



GENERAL CATALOGUE

CARLTSØ
SAFETY TOOLS®
If you just had the right tools

High Quality Safety Tools
Help achieve SAFER use in hazardous environments





Carltsø Safety Tools®

If you just had the right tools!

Any place where there is a risk of explosion
or fire, safety tools are required

When talking about safety, everything
matters and you deserve the best...

Carltsø Safety Tools®





**Non-Sparking
Non-Magnetic
Corrosive-Resistant**

**High Quality Safety Tools
Help achieve SAFER use in
hazardous environments**



Carltsø Safety Tools®

More than 50 years of experience in safety tools

Since 1956 Carltsø Safety Tools is known as the most reliable brand in non-sparking, non-magnetic, corrosion resistant hand tools. Trusted by companies in oil & gas sector around the world and all industries where safety tools are required.

High quality design and manufacturing processes

Carltsø safety Tools Company is ISO 9001 certified strict quality control processes are in place to ensure our tools meet high quality Standards. Moreover every tool is checked and tested before leaving the factory. All our products have LIFE TIME WARRANTY against breakage or performance failure under normal use.

Customer satisfaction

Finding what you need in Carltsø Safety Tools range of products: There are 3000 items available in 2 different special alloys – Aluminum Bronze and Beryllium copper. Custom made Safety Tools can also be provided on request. We are dedicated to Safety Tools – our teams are specialized to provide you the best support.



CARLTSOE SAFETY TOOLS® Non Magnetic and Non-Sparking hand tools for use in hazardous environments and ATEX(*) zones

CARLTSOE SAFETY TOOLS® offers a complete line of high quality, non-sparking, non-magnetic and corrosion resistant safety tools that are manufactured for use in high risk explosive areas.

CARLTSOE beryllium copper (BeCu) and Aluminum Bronze (AlBz) tools help fulfill the recommendation in the European ATEX(*) directive for work in zones 0, 1 and 2 (gas, mists or vapors); zones 20, 21 and 22 (dusts); and M1, M2 for mining(**)



Carltsoe safety tools are made from materials approved by the Federal Institute for Material Research and Testing, Berlin, Germany.



How to choose the correct tools for your application

	Aluminum bronze (AlBz)	Beryllium copper (BeCu)
Zone Compatibility	helps fulfill the recommendation in the European ATEX(*) directive for work in zones 0, 1, 2, 20, 21 and 22	helps fulfill the recommendation in the European ATEX(*) directive for work in zones 0, 1, 2, 20, 21 and 22
Hardness	228 HB 30	350 HB 30
Durability	Good	Very good
Magnetic properties	Low magnetic permeability	Very low magnetic permeability
Composition	Cu: 78%, Al: 10.0%-11.5%, Fe: 3.5%-5.0%, Ni: 4.0%-5.5%, Mg: 3.5%, Other: 0.5%	Be: 1.8%-2.0%, Co: 0.20%-0.6%, other:0.5%, Rest copper

(*) Hand tools are not within the scope of European ATEX 94/9/EC (tools are not own source of ignition). Risks assessments must be made by the employer of the workers using hand tools (see EN 1127-1, EN 13463-1)

() DISCLAIMER: Final responsibility remains with the employer of the workers using hand tools, based on his risk assessments (EN 1127-1, EN 13463-1).**

The above text is not binding and it shall always be referred to the original documents



Carltsø Non-Sparking Safety Tools are recommended for use where hazardous, flammable or combustible vapors, liquids, dusts or residues are present and should be used by all industrial safety programs.

Carltsø Non-Magnetic Tools can be used around sensitive magnetic equipment, including scanners, de-mining and disarming.

Carltsø Corrosion Resistant Safety Tools are the ideal choice when working in marine and offshore environments. Corrosion and rust can be extremely dangerous in hazardous environments. Impacts involving rust can initiate a thermal reaction which can cause an ignition in an explosive atmosphere.

It is important that the user of Carltsø Safety Tools keeps the tools in clean working order. Like other personal protection equipment, it is each user's duty to inspect the tools before use.

Tools for use in potentially explosive atmospheres ATEX(*) Zones EN 1127-1:2011 Annex A (Informative)

Those responsible for operating plants and processes where potentially explosive atmospheres exist should provide information to all who work on the site about the safe use of hand tools.

Carltsø Copper-Beryllium Tools (CuBe) help fulfill the recommendation in the European ATEX(*) directive for working in Zone 0,1 and 2 (Gas, Mists or Vapors), Zones 20, 21 and 22 (Dusts), M1 and M2 for mining.

Carltsø Aluminum-Bronze Tools (AlBz) help fulfill the recommendation in the European ATEX(*) directive for work in Zones 1 and 2.

(*)Hand tools are not within the scope of European ATEX 94/9/EC (tools are not own source of ignition). Risks assessment must be made by the employer of the workers using hand tools (see EN 1127-1, EN 13463-1). Final responsibility remains with the employer of the workers using hand tools, based on his risk assessments (EN 1127-1, EN 13463-1).

The above mentioned text is not binding and it shall always be referred to the original documents.





Gas, Mists or Vapors

- Zone 0 - An atmosphere where a mixture of air and flammable substances in the form of gas, vapor or mist is present frequently, continuously or for long periods.
- Zone 1 - An atmosphere where a mixture of air and flammable substances in the form of gas, vapor or mist is likely to occur in normal operation occasionally.
- Zone 2 - An atmosphere where a mixture of air and flammable substances in the form of gas, vapor or mist is not likely to occur in normal operation but, if it does occur, will persist for only a short period.

Dusts

- Zone 20 - An atmosphere where a cloud of combustible dust in the air is present frequently, continuously or for long periods.
- Zone 21 - An atmosphere where a cloud of combustible dust in the air is likely to occur in normal operation occasionally.
- Zone 22 - An atmosphere where a cloud of combustible dust in the air is not likely to occur in normal operation but, if it does occur, will persist for only a short period.

Carltssoe Safety Tools[®]



Carlitsoe Safety Tools®

If you just had the right tools



INDEX

TIGHTENING

*Wrenches Pipe Wrenches Sockets/Ratchets
Allen Keys Valve Wheel Wrenches Pliers Screwdrivers*

01-36



STRIKING

Hammers Punches Chisels Wedges

37-48



CUTTING

Knives Scrapers Saws Files

49-56



UTILITIES

Shovels Bars Forks Axels

57-62

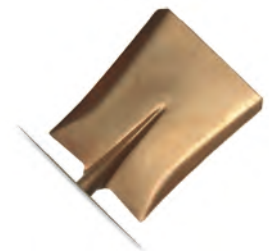

MISCELLANEOUS

Brushes Clamps Bung Wrenches Special Kits

63-73



INDEX

Description	Part	Page	Description	Part	Page
Angle Tracing Point	1302	61	Hatchet	1202	62
Axe, Pick Head	1203	62	Hoe, Planters'/ Mixing,		
Bar			Angled Blade	1015	60
<i>Crow</i>	1303	61	Kits		
<i>Pinch</i>	1301	61	<i>Allen/ Hex Key</i>	209LSKit-7	35
Brushes			<i>Allen/ Hex Key</i>	209SKit-7	35
<i>Cup</i>	1000	64	<i>Allen Wrench Kit</i>		
<i>Cup, Knot Wire</i>	998	64	<i>Copper Beryllium (CuBe only)</i>	209Kit	11
<i>Flat Back, Scratch</i>	1002	64	<i>Cleaning Kit, 21 Piece</i>	4000-21	72
<i>Straight Handle, Scratch</i>	1001	64	<i>Combination Wrench Kit</i>	206Kit	8
<i>Wheel</i>	1003	65	<i>Double End Box Wrench</i>		
Caulking Tool	308A	46	<i>Offset Kit</i>	202FKit	5
Caulking Tool	308B	60	<i>Double Open End Wrench Kit</i>	203Kit	6
Chain Block/ Hoist	903	66	<i>Engineer's Tool Kit,</i>		
Chisels			<i>Heavy Duty, 30 Piece</i>	3000-30	73
<i>6-Point</i>	304A	45	<i>Engineer's Tool Mini Kit,</i>		
<i>8-Point</i>	304S	45	<i>4 Piece</i>	2204-4	69
<i>Bull Point</i>	306	46	<i>Hazmat Kit, 16 piece</i>	2300-16	71
<i>Cape</i>	305	46	<i>Machinist's Tool Kit,</i>		
<i>Caulking Tool</i>	308A	46	<i>10 Piece</i>	2211-10	71
<i>Diamond Point</i>	307	46	<i>Machinist's Tool Mini Kit,</i>		
<i>For Machines</i>	309CP	47	<i>6 Piece</i>	2206-6	70
<i>For Machines</i>	309RP	47	<i>Marine Kit, 19 Piece</i>	2200-19	70
<i>Hand</i>	304	45	<i>Safety Tools Kit, 23 Piece</i>	2000-23	72
<i>Pneumatic, Bull Point</i>	318R, 320R	48	<i>Screwdrive Kit</i>		
<i>Pneumatic, Flat End</i>	318F, 320F	48	<i>Copper Beryllium (CuBe only)</i>	801Kit-6	36
<i>Pneumatic, Scaling</i>	312, 312L	47	<i>Screwdrive, Torx Kit</i>		
<i>Pneumatic, Scaling</i>	314	47	<i>Copper Beryllium (CuBe only)</i>	804Kit-5	36
<i>Pneumatic, Spade End</i>	340	48	<i>Socket, 1/4 " Drive</i>	1520-14	14
Clamps			<i>Socket, 1/2 " Drive</i>	1530-Kit	15
<i>G-Type</i>	901	65	<i>Socket, 3/4 " Drive</i>	1540-13	16
<i>Grounding</i>	211	65	Knife		
Crate Opener	113S	41	<i>Common</i>	409	50
Drifts			<i>Common</i>	410	50
<i>Cylindrical</i>	301	44	<i>Common</i>	410S	50
<i>Pin, Straight Type</i>	301C	44	<i>Putty/ Hand Scraper</i>	408	50
Drum Opener, Carbide	1013	59	Needle, For Air Needle Scalers	308	54
Dust Pan	1004	58	Parallel Vice	902	66
Files			Pick, Railroad Or Clay	1008	59
<i>Flat, Bastard</i>	411	56	Pipe Cutter	1512	54
<i>Half Round, Bastard</i>	411F	56	Pliers		
<i>Round, Bastard</i>	411R	56	<i>Adjustable Combination</i>	605	32
Flange Spreader	1102	68	<i>Cutting</i>	603	53
Fork, Garden	1010	59	<i>Diagonal Cutting</i>	601	53
Hammers			<i>Diagonal Cutting, Heavy Duty</i>	601HD	53
<i>Ball Peen</i>	101U	38	<i>Flat Nose (DIN ISO 5745)</i>	606	32
<i>Bricklayers'</i>	112U	40	<i>Groove Joint</i>	604	31
<i>Claw</i>	122U	41	<i>Lineman's, Side Cutting</i>	612	33
<i>Club</i>	108U	40	<i>Long-Nose W/ Side Cutter</i>		
<i>Cross Peen Engineer's</i>	102U	38	<i>(DIN ISO 5745)</i>	611	33
<i>Cross Peen, German Type</i>	1041	42	<i>Pipe</i>	602	31
<i>Cutoff</i>	105U	39	<i>Round Nose (DIN ISO 5745)</i>	616	32
<i>Double-Face engineer's</i>	109U	40	<i>Wire Stripping</i>	607	54
<i>Double-Face Machinists'</i>	103U	38	<i>Snap Ring, Outside</i>	614	33
<i>Mallet</i>	110U	39	<i>Snap Ring, Outside</i>	615	34
<i>Scaling</i>	106U	40	<i>Swedish (DIN 5234)</i>	505	31
<i>Sledge</i>	104U	39			
<i>Sledge, German Type</i>	6475	42			

Description	Part	Page	Description	Part	Page
Punches			Trolley For Chain Block/ Hoist	903T	66
<i>Center</i>	303	45	Tweezer	610	67
<i>Pin</i>	301P	43		610S	68
Saws			Valve Wheel Hook	207F	8
<i>Hand</i>	119	55	Wedges		
<i>Hand Frame</i>	118A	55	<i>Banana</i>	1101B	43
<i>Blade, Hack</i>	118B	55	<i>Flange</i>	1101	43
Scrapers			Wrenches		
<i>Angle</i>	402	51	<i>Adjustable End</i>	501	12
<i>Deck</i>	405	51	<i>Allen/Hex Key</i>		
<i>Flat</i>	401	51	<i>(Ball Point, Long Type)</i>	209L	11
<i>Long Blade</i>	407	52	<i>Allen/Hex Key (DIN 911)</i>	209	10
<i>Pick And Scaler</i>	1014	60	<i>Box End, Double,</i>		
<i>Plate</i>	406	52	<i>Offset (12-point)</i>	202F	5
<i>Triangular</i>	403	51	<i>Box End, Double,</i>		
<i>Scraper</i>	407S	52	<i>Straight Type (12-point)</i>	202	4
Screwdrivers			<i>Box, For Extension</i>	215	12
<i>Allen/ Hex Key (CuBe only)</i>	209	34	<i>Bung, Fits 3/4 " & 2 " Bungs</i>	110	69
<i>Allen/ Hex Key (CuBe only)</i>	209L	34	<i>Bung, For 22 Different Bungs</i>	110S	69
<i>Offset</i>	802	36	<i>Chain Pipe</i>	600	13
<i>Phillips</i>	803	34	<i>Combination</i>	206	7
<i>Standard</i>	801	34	<i>Combination,</i>		
<i>Striking</i>	801S	35	<i>Box End, with Pin</i>	204S	7
Scriber/Marking Tool	302	68	<i>Extension for Box Wrench</i>	216	11
Shackle	900	65	<i>Crowfoot</i>	1514B	30
Shovels			<i>Gas Tube</i>	1506	21
<i>Round Point with Long Handle</i>	1006	58	<i>Monkey</i>	503	13
<i>Spade, Edging with D-Grip</i>	1007	58	<i>Open End</i>	203	6
<i>Square Point with Long Handle</i>	1005	58	<i>Pipe (American Type)</i>	502	13
Sockets			<i>Ratchet</i>	504S	23
<i>1/4 " drive</i>	1503AA	14	<i>Ratchet</i>	1501S	22
<i>3/8 " drive</i>	1503A	14	<i>Socket, L-Type (6-point)</i>	702	23
<i>1/2 " drive</i>	1503B	15	<i>Spanner Adjustable</i>	208S	9
<i>3/4 " drive</i>	1503C	16	<i>Spanner, Fixed (DIN 1810)</i>	208	10
<i>1 " drive</i>	1503D	17	<i>Striking Box</i>		
<i>Adapter/Converter</i>	1509	22	<i>(12-point, DIN 7444)</i>	201B	3
<i>Deep, 1/4 " drive</i>	1610	27	<i>Striking Box,</i>		
<i>Deep, 3/8 " drive</i>	1620	28	<i>Offset (12-point)</i>	201F	4
<i>Deep, 1/2 " drive</i>	1630	28	<i>Striking, Open End</i>	200	2
<i>Deep, 3/4 " drive</i>	1640	29	<i>Spanner, Adjustable For</i>		
<i>Deep, 1 " drive</i>	1650	29	<i>Double Hole</i>	208DH	9
<i>Deep Impact, 3/8 " drive</i>	1820	21	<i>Torque</i>	1401	30
<i>Deep Impact, 1/2 " drive</i>	1830	21	<i>Valve</i>	207	8
<i>Deep Impact, 3/4 " drive</i>	1840	25	<i>Valve Wheel (DIN 87311)</i>	207S	9
<i>Deep Impact, 1 " drive</i>	1850	25			
<i>Deep Impact, 1-1/2 " drive</i>	1860	26			
<i>Driver Handle</i>	1504S	26			
<i>Extension, Bar</i>	1504	27			
<i>Impact, 3/8 " drive</i>	1720	22			
<i>Impact, 1/2 " drive</i>	1730	22			
<i>Impact, 3/4 " drive</i>	1740	17			
<i>Impact, 1 " drive</i>	1750	18			
<i>Impact, 1-1/2 " drive</i>	1760	18			
<i>Joint, Universal</i>	1507	19			
<i>Sliding, Bar</i>	1502	20			
<i>With Hexagon Head, 1/2 " Drive</i>	209HB	24			

TIGHTENING

*Wrenches Pipe Wrenches Sockets/Ratchets
Allen Keys Valve Wheel Wrenches Pliers Screwdrivers*



When ordering, specify:
 A=Aluminum Bronze
 B=Copper Beryllium
 Example: 200-17A
 OR
 200-17B



200 Wrench, Striking, Open End (DIN 133)

- Maulschlagschlüssel
- Clé à frapper à fourche
- Llave de boca de golpe

No.	S mm	L mm	⚖ kg
200-17B	17	140	0.18
200-18B	18	140	0.18
200-19B	19	140	0.19
200-22B	22	150	0.26
200-24B	24	160	0.33
200-26B	26	180	0.43
200-27B	27	180	0.43
200-28B	28	180	0.43
200-29B	29	190	0.53
200-30B	30	190	0.53
200-32B	32	195	0.58
200-35B	35	210	0.85
200-36B	36	210	0.85
200-37B	37	210	0.85
200-38B	38	225	0.98
200-41B	41	225	1.04
200-42B	42	225	1.10
200-46B	46	225	1.48
200-50B	50	280	1.71
200-52B	52	280	2.20
200-55B	55	310	2.20
200-56B	56	310	2.20
200-60B	60	320	2.76
200-63B	63	350	4.36
200-65B	65	350	4.36
200-70B	70	375	4.85
200-75B	75	395	5.56
200-80B	80	410	6.20
200-85B	85	415	6.50
200-90B	90	435	7.45
200-95B	95	450	8.10
200-100B	100	485	9.90
200-105B	105	485	9.90
200-110B	110	510	19.5
200-115B	115	510	19.5
200-120B	120	545	23.0
200-125B	125	545	23.0
200-130B	130	575	28.0
200-135B	135	575	28.0
200-145B	145	640	38.0
200-150B	150	640	38.0
200-155B	155	640	38.0

No.	S inch	L inch	wt. lbs.
200U-010B	11/16	5 ⁹ / ₁₆	0.40
200U-015B	3/4	5 ⁹ / ₁₆	0.42
200U-020B	7/8	6	0.57
200U-025B	15/16	6 ³ / ₈	0.73
200U-030B	1	7 ³ / ₁₆	0.95
200U-035B	1 ¹ / ₁₆	7 ³ / ₁₆	0.95
200U-040B	1 ¹ / ₈	7 ³ / ₁₆	0.95
200U-045B	1 ³ / ₁₆	7 ⁹ / ₁₆	1.17
200U-050B	1 ¹ / ₄	7 ⁹ / ₁₆	1.17
200U-055B	1 ⁵ / ₁₆	7 ³ / ₄	1.28
200U-060B	1 ³ / ₈	8 ³ / ₈	1.87
200U-065B	1 ⁷ / ₁₆	8 ³ / ₈	1.87
200U-070B	1 ¹ / ₂	8 ³ / ₈	2.16
200U-080B	1 ⁵ / ₈	9	2.29
200U-085B	1 ¹¹ / ₁₆	9	2.43
200U-095B	1 ¹³ / ₁₆	9	3.26
200U-105B	2	11 ³ / ₁₆	3.77
200U-110B	2 ¹ / ₁₆	11 ³ / ₁₆	4.85
200U-120B	2 ³ / ₁₆	12 ³ / ₈	4.85
200U-125B	2 ¹ / ₄	12 ³ / ₈	4.85
200U-135B	2 ³ / ₈	12 ³ / ₄	6.08
200U-145B	2 ¹ / ₂	14	9.61
200U-150B	2 ⁹ / ₁₆	14	9.61
200U-160B	2 ³ / ₄	15	10.69
200U-175B	3	15 ³ / ₄	12.26
200U-182B	3 ³ / ₁₆	16 ³ / ₈	13.67
200U-190B	3 ³ / ₈	16 ⁹ / ₁₆	14.33
200U-198B	3 ⁹ / ₁₆	17 ³ / ₈	16.42
200U-205B	3 ³ / ₄	18	17.86
200U-210B	3 ⁷ / ₈	18	17.86
200U-215B	4	19 ¹ / ₈	9.90
200U-220B	4 ¹ / ₈	19 ¹ / ₈	9.90
200U-225B	4 ⁵ / ₁₆	20 ¹ / ₈	19.50
200U-240B	4 ⁹ / ₁₆	20 ¹ / ₈	19.50
200U-250B	4 ¹¹ / ₁₆	21 ¹ / ₂	23.00
200U-265B	4 ¹⁵ / ₁₆	21 ¹ / ₂	23.00
200U-270B	5 ³ / ₈	22 ⁵ / ₈	28.00
200U-300B	6	25 ³ / ₁₆	38.00

*OTHER SIZES ON REQUEST

When ordering, specify:
A=Aluminum Bronze
B=Copper Beryllium
 Example:210B-17A
 or
 210B-17B

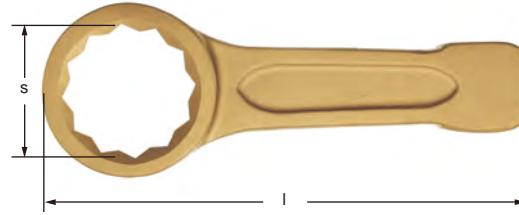

201B Wrench, Striking, Box 12-Point (DIN7444)

- Ringschiagschlüssel
- Clé à frapper polygonale
- Llave de cajón de golpe

No.	s mm	l mm	△ kg
201B-17	17	140	0.18
201B-18	18	140	0.18
201B-19	19	140	0.18
201B-20	20	160	0.22
201B-21	21	160	0.22
201B-22	22	160	0.22
201B-23	23	160	0.22
201B-24	24	160	0.27
201B-25	25	160	0.27
201B-26	26	180	0.35
201B-27	27	180	0.35
201B-28	28	180	0.35
201B-29	29	190	0.51
201B-30	30	190	0.51
201B-31	31	190	0.51
201B-32	32	195	0.53
201B-33	33	195	0.53
201B-34	34	205	0.56
201B-35	35	205	0.56
201B-36	36	205	0.56
201B-37	37	205	0.56
201B-38	38	225	0.81
201B-41	41	225	0.81
201B-42	42	225	0.81
201B-46	46	240	1.23
201B-47	47	240	1.23
201B-50	50	250	1.30
201B-52	52	250	1.71
201B-55	55	270	1.71
201B-60	60	270	1.93
201B-65	65	290	2.02
201B-70	70	320	2.78
201B-75	75	335	2.92
201B-80	80	340	3.28
201B-85	85	345	4.19
201B-90	90	375	5.18
201B-95	95	380	5.26
201B-100	100	405	6.30
201B-105	105	410	6.65
201B-110	110	450	8.50
201B-115	115	450	8.50
201B-120	120	475	12.75
201B-125	125	475	12.75
201B-130	130	505	17.25
201B-135	135	505	17.25
201B-145	145	575	21.00
201B-150	150	575	21.00
201B-155	155	575	21.00

No.	s inch	l inch	wt. lbs.
201BU-005	11/16	5 ⁹ / ₁₆	0.40
201BU-010	3/4	5 ⁹ / ₁₆	0.40
201BU-012	13/16	6 ³ / ₈	0.49
201BU-015	7/8	6 ³ / ₈	0.49
201BU-017	15/16	6 ³ / ₈	0.60
201BU-020	1	6 ³ / ₈	0.60
201BU-025	1 ¹ / ₁₆	7 ³ / ₁₆	0.77
201BU-030	1 ¹ / ₈	7 ³ / ₁₆	0.77
201BU-035	1 ³ / ₁₆	7 ⁹ / ₁₆	1.12
201BU-040	1 ¹ / ₄	7 ⁹ / ₁₆	1.12
201BU-045	1 ⁵ / ₁₆	7 ³ / ₄	1.17
201BU-050	1 ³ / ₈	8 ³ / ₁₆	1.23
201BU-055	1 ⁷ / ₁₆	8 ³ / ₁₆	1.23
201BU-060	1 ¹ / ₂	9	1.79
201BU-065	1 ⁹ / ₁₆	9	1.79
201BU-070	1 ⁵ / ₈	9	1.79
201BU-075	1 ¹¹ / ₁₆	9	1.79
201BU-080	1 ³ / ₄	9 ⁹ / ₁₆	2.71
201BU-085	1 ¹³ / ₁₆	9 ⁹ / ₁₆	2.71
201BU-090	1 ⁷ / ₈	9 ⁹ / ₁₆	2.71
201BU-095	2	10	2.87
201BU-100	2 ¹ / ₁₆	10	3.77
201BU-105	2 ¹ / ₈	10	3.77
201BU-110	2 ³ / ₁₆	10 ³ / ₄	3.77
201BU-115	2 ¹ / ₄	10 ³ / ₄	4.02
201BU-120	2 ⁵ / ₁₆	10 ³ / ₄	4.02
201BU-125	2 ³ / ₈	10 ³ / ₄	4.25
201BU-130	2 ⁷ / ₁₆	11 ⁹ / ₁₆	4.45
201BU-135	2 ¹ / ₂	11 ⁹ / ₁₆	4.45
201BU-140	2 ⁹ / ₁₆	11 ⁹ / ₁₆	4.45
201BU-150	2 ³ / ₄	12 ³ / ₄	6.13
201BU-165	3	13 ³ / ₈	6.44
201BU-170	3 ¹ / ₈	13 ³ / ₄	7.23
201BU-175	3 ¹ / ₄	13 ³ / ₄	7.23
201BU-177	3 ³ / ₁₆	13 ³ / ₄	7.23
201BU-180	3 ³ / ₈	14	9.24
201BU-187	3 ⁹ / ₁₆	15	11.42
201BU-195	3 ³ / ₄	15 ³ / ₈	11.60
201BU-205	4	16 ³ / ₈	13.89
201BU-212	4 ³ / ₁₆	16 ⁹ / ₁₆	14.66
201BU-215	4 ⁵ / ₁₆	17 ¹¹ / ₁₆	18.74
201BU-220	4 ⁹ / ₁₆	17 ¹¹ / ₁₆	18.74
201BU-225	4 ¹¹ / ₁₆	18 ¹¹ / ₁₆	28.11
201BU-230	4 ¹⁵ / ₁₆	18 ¹¹ / ₁₆	28.11
201BU-235	5 ¹ / ₈	19 ²⁷ / ₃₂	38.03
201BU-250	5 ³ / ₈	19 ²⁷ / ₃₂	38.03
201BU-270	5 ¹¹ / ₁₆	22 ⁵ / ₈	46.30
201BU-285	6	22 ⁵ / ₈	46.30

*OTHER SIZES ON REQUEST

When ordering, specify:
A=Aluminum Bronze
B=Copper Beryllium
 Example: 201F-27A
 or
 201F-27B

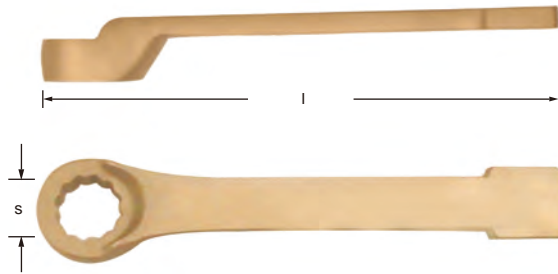

201F Wrench, Striking Box, Offset 12-Point

- Ringschlagschlüssel, gekröpft
- Clé à frapper polygonale, coudée
- Llave de cajón de golpe, acodada

No.	S mm	l mm	ΔΔ kg
201F-27	27	245	0.75
201F-30	30	270	0.82
201F-32	32	270	0.82
201F-36	36	280	1.30
201F-41	41	310	1.35
201F-46	46	320	1.90
201F-50	50	330	2.12
201F-55	55	340	2.52
201F-60	60	355	3.01
201F-65	65	380	3.55
201F-70	70	400	4.30

No.	S inch	l inch	wt. lbs.
201FU-005	1 1/16	19 3/4	1.65
201FU-010	1 3/16	10 3/4	1.81
201FU-015	1 1/4	10 3/4	1.81
201FU-020	1 7/16	11 3/16	2.87
201FU-025	1 5/8	12 3/8	2.98
201FU-030	1 13/16	12 3/4	4.19
201FU-035	2	13 3/16	4.67
201FU-040	2 3/16	13 9/16	5.56
201FU-045	2 3/8	14 3/16	6.64
201FU-050	2 9/16	15 3/16	7.83
201FU-055	2 3/4	16	9.48

*OTHER SIZES ON REQUEST



202 Wrench, Box End, Double Straight Type, 12-Point

- Doppelringschlüssel gerade
- Clé polygonale double droite
- Llave de cajón doble tipo recto

No.	S ₁ X S ₂ mm	l mm	ΔΔ kg
202-67	6X7	80	0.03
202-89	8X9	95	0.04
202-910	9X10	105	0.06
202-1214	12X14	130	0.10
202-1415	14X15	130	0.09
202-1719	17X19	150	0.14
202-1922	19X22	185	0.18
202-2224	22X24	190	0.22
202-2427	24X27	220	0.29
202-2730	27X30	270	0.42
202-3032	30X32	270	0.48
202-3236	32X36	305	0.60

No.	S ₁ X S ₂ inch	l inch	wt. lbs.
202U-005	7/32X1/4	3 3/4	0.09
202U-010	1/4X5/16	3 3/4	0.09
202U-015	11/16X3/4	3 3/4	0.09
202U-020	3/8X7/16	5 3/16	0.21
202U-030	7/16X9/16	5 3/16	0.21
202U-070	11/16X3/4	6	0.31
202U-080	3/4X7/8	7 3/8	0.40
202U-095	7/8X15/16	7 9/16	0.49
202U-120	15/16X1 1/16	8 3/4	0.64
202U-135	1 1/16X1 3/16	10 3/4	0.93
202U-150	1 3/16X1 1/4	10 3/4	1.06
202U-160	1 1/4X1 7/16	12 3/16	1.32

*OTHER SIZES ON REQUEST

When ordering, specify:

A=Aluminum Bronze

B=Copper Beryllium

Example:202F-67A

or

202F-67B

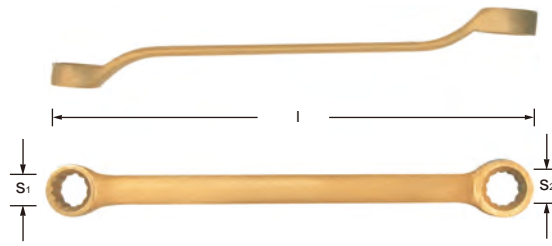

202F

Wrench, Box End, Double Offset Type, 12-Point

- Doppelringschlüssel gekröpft
- Clé polygonale double contre-coudée
- Llave de cajón doble tipo acodado

No.	S ₁ X S ₂ mm	l mm	ΔΔ kg	No.	S ₁ X S ₂ inch	l inch	wt. lbs.
202F-67	6X7	155	0.03	202FU-005	7/32X1/4	4 ^{3/4}	0.06
202F-78	7X8	155	0.03	202FU-010	1/4X9/32	4 ^{3/4}	0.06
202F-79	7X9	155	0.03	202FU-015	1/4X5/16	5 ^{3/16}	0.07
202F-89	8X9	155	0.04	202FU-020	1/4X3/8	5 ^{3/16}	0.07
202F-810	8X10	170	0.04	202FU-025	5/16X3/8	5 ^{3/16}	0.09
202F-911	9X11	170	0.08	202FU-030	3/8X7/16	5 ^{3/16}	0.18
202F-1012	10X12	180	0.08	202FU-035	3/8X9/16	7 ^{3/16}	0.18
202F-1013	10X13	180	0.08	202FU-040	7/16X1/2	7 ^{3/16}	0.22
202F-1113	11X13	180	0.10	202FU-045	7/16X9/16	7 ^{3/16}	0.22
202F-1213	12X13	180	0.10	202FU-050	1/2X9/16	7 ^{3/16}	0.22
202F-1214	12X14	200	0.10	202FU-055	19/32X1/2	7 ^{3/16}	0.22
202F-1315	13X15	220	0.14	202FU-060	9/16X5/8	8 ^{3/4}	0.33
202F-1415	14X15	220	0.15	202FU-065	5/8X11/16	8 ^{3/4}	0.44
202F-1417	14X17	230	0.15	202FU-070	5/8X3/4	8 ^{3/4}	0.49
202F-1617	16X17	260	0.20	202FU-075	11/16X3/4	10	0.49
202F-1618	16X18	260	0.18	202FU-080	25/32X11/16	10	0.49
202F-1719	17X19	280	0.22	202FU-085	7/8X11/16	11 ^{3/16}	0.62
202F-1819	18X19	280	0.22	202FU-090	3/4X13/16	11 ^{3/16}	0.62
202F-1722	17X22	330	0.28	202FU-095	3/4X7/8	11 ^{3/16}	0.62
202F-1922	19X22	330	0.28	202FU-100	3/4X15/16	12 ^{3/8}	0.93
202F-2022	20X22	330	0.28	202FU-105	7/8X13/16	12 ^{3/8}	0.93
202F-1924	19X24	360	0.42	202FU-110	7/8X15/16	12 ^{3/8}	0.93
202F-2123	21X23	360	0.42	202FU-115	7/8X31/32	12 ^{3/8}	0.93
202F-2224	22X24	360	0.42	202FU-120	7/8X1	12 ^{3/8}	0.93
202F-2227	22X27	360	0.50	202FU-125	7/8X1 ^{1/16}	13 ^{9/16}	1.17
202F-2426	24X26	400	0.50	202FU-130	15X16X1	13 ^{9/16}	1.17
202F-2427	24X27	400	0.50	202FU-135	15/16X1 ^{1/16}	13 ^{9/16}	1.10
202F-2528	25X28	400	0.53	202FU-140	15/16X1 ^{3/16}	14 ^{3/8}	1.19
202F-2430	24X30	410	0.54	202FU-150	1X1 ^{1/8}	13 ^{9/16}	1.17
202F-2730	27X30	410	0.55	202FU-155	1 ^{1/16} X1 ^{1/8}	14 ^{3/8}	1.21
202F-2732	27X32	410	0.72	202FU-160	1 ^{1/16} X1 ^{1/4}	15 ^{3/16}	1.59
202F-3032	30X32	430	0.72	202FU-165	1 ^{1/8} X1 ^{5/16}	15 ^{3/16}	1.59
202F-3036	30X36	480	0.99	202FU-170	1 ^{3/16} X1 ^{1/4}	15 ^{3/16}	1.59
202F-3236	32X36	480	0.99	202FU-175	1 ^{3/16} X1 ^{7/16}	16 ^{3/4}	2.18
202F-3436	34X36	480	0.99	202FU-185	1 ^{1/4} X1 ^{7/16}	16 ^{3/4}	2.18
202F-3641	36X41	510	1.28	202FU-190	1 ^{7/16} X1 ^{5/8}	18 ^{3/16}	2.18
202F-4146	41X46	580	1.60	202FU-195	1 ^{5/8} X1 ^{13/16}	18 ^{3/4}	3.53
202F-4650	46X50	630	2.08	202FU-200	1 ^{13/16} X2	19 ^{9/16}	4.59
202F-5055	50X55	690	2.52	202FU-205	2X2 ^{3/16}	20 ^{3/8}	5.56

202FKit

Double End Box Wrench Offset Kit

- Doppelringschlüssel gekröpft, garnitur
- Clé polygonale double contre-coudée, jeu
- Llave de cajón doble tipo acodado, juego

No.	Parts	S mm	ΔΔ kg
202FKIT-8	8	6X7,8X9,10X11,12X13,14X15,16X17,18X19,20X22	1.42
202FKIT-12	12	6X7,8X9,10X11,12X13,14X15,16X17,18X19,20X22,21X23,24X26,27X32,30X34	4.81

*PLASTIC CASE INCLUDED

When ordering, specify:
A=Aluminum Bronze
B=Copper Beryllium
Example:203-67A

or
203-67B

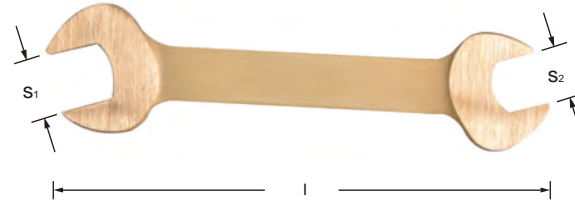

203 Wrench, Open End, Double

- Doppelmaulschlüssel
- Clé à fourche double
- Llave de boca doble

No.	S ₁ X S ₂ mm	l mm	Δ kg	No.	S ₁ X S ₂ inch	l inch	wt. lbs.
203-67	6X7	90	0.03	203U-005	7/32X1/4	3 ⁹ / ₁₆	0.07
203-68	6X8	90	0.03	203U-010	1/4X9/32	4	0.07
203-78	7X8	100	0.03	203U-015	1/4X5/16	3 ⁹ / ₁₆	0.07
203-79	7X9	100	0.03	203U-020	1/4X3/8	4	0.07
203-89	8X9	100	0.04	203U-025	5/16X3/8	4	0.09
203-810	8X10	100	0.04	203U-030	3/8X7/16	4 ³ / ₄	0.13
203-910	9X10	100	0.04	203U-035	7/16X1/2	5 ³ / ₁₆	0.14
203-911	9X11	120	0.06	203U-040	7/16X9/16	5 ³ / ₁₆	0.14
203-1012	10X12	120	0.06	203U-045	1/2X9/16	5 ³ / ₈	0.22
203-1114	11X14	130	0.06	203U-050	1/2X5/8	5 ³ / ₈	0.31
203-1214	12X14	135	0.06	203U-055	1/2X11/16	6	0.31
203-1315	13X15	150	0.10	203U-060	9/16X5/8	6	0.31
203-1415	14X15	150	0.14	203U-065	9/16X11/16	6	0.31
203-1417	14X17	150	0.14	203U-070	9/16X3/4	6 ⁹ / ₁₆	0.31
203-1618	16X18	165	0.14	203U-085	5/8X11/16	6 ⁹ / ₁₆	0.31
203-1719	17X19	165	0.19	203U-090	5/8X3/4	6 ⁹ / ₁₆	0.42
203-1922	19X22	180	0.23	203U-095	3/4X11/16	6 ⁹ / ₁₆	0.42
203-2022	20X22	180	0.23	203U-115	3/4X7/8	7 ³ / ₁₆	0.51
203-2123	21X23	210	0.26	203U-130	13/16X7/8	8 ³ / ₈	0.57
203-2224	22X24	210	0.29	203U-135	8X15/16	8 ³ / ₈	0.64
203-2427	24X27	230	0.47	203U-160	15/16X1 ¹ / ₁₆	9 ³ / ₁₆	1.04
203-2430	24X30	250	0.52	203U-165	15/16X1 ³ / ₁₆	9 ³ / ₁₆	0.95
203-2528	25X28	230	0.43	203U-175	15/16X1 ³ / ₁₆	10	1.15
203-2730	27X30	250	0.53	203U-185	1 ¹ / ₁₆ X1 ³ / ₁₆	10	1.17
203-2732	27X32	250	0.42	203U-190	1 ¹ / ₁₆ X1 ¹ / ₄	10	0.93
203-3032	30X32	250	0.43	203U-210	1 ³ / ₁₆ X1 ¹ / ₄	10	0.95
203-3236	32X36	290	0.78	203U-220	1 ¹ / ₄ X1 ⁷ / ₁₆	11 ⁹ / ₁₆	1.72
203-3641	36X41	315	1.04	203U-240	1 ⁷ / ₁₆ X1 ⁵ / ₈	12 ⁹ / ₁₆	2.29
203-4146	41X46	365	1.54	203U-250	1 ⁵ / ₈ X1 ¹³ / ₁₆	14 ⁹ / ₁₆	3.40
203-4650	46X50	370	1.73	203U-265	1 ¹³ / ₁₆ X2	14 ³ / ₄	3.81
203-5055	50X55	385	2.39	203U-270	2X2 ³ / ₁₆	15 ³ / ₈	5.27
203-5560	55X60	415	2.81	203U-290	2 ³ / ₁₆ X2 ³ / ₈	16 ⁹ / ₁₆	6.20
203-6065	60X65	435	3.98	203U-300	2 ⁹ / ₁₆ X2 ³ / ₄	18 ³ / ₄	8.77

* OTHER SIZES ON REQUEST

203Kit Double Open End Wrench Kit

- Doppelmaulschlüssel, garnitur
- Clé à fourche double, jeu
- Llave de boca doble, juego

No.	Parts	s mm	Δ kg
203KIT-8	8	6X7,8X9,10X11,12X13,14X15,16X17,18X20,19X22	0.84
203KIT-12	12	6X7,8X9,10X11,12X13,14X15,16X17,18X19,20X22,21X23,24X26,27X32,30X34	2.18

*PLASTIC CASE INCLUDED

When ordering, specify:

A=Aluminum Bronze

B=Copper Beryllium

Example:204S-22A

or

204S-22B

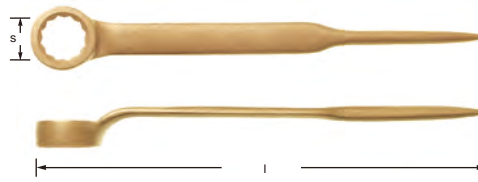

204S Wrench, Construction With Pin, (Ring End)

- Montageringschlüssel gekröpft
- Clé fermée à broche, coudée
- Llave de construcción, acodada con perno

No.	S mm	l mm	ΔΔ kg
204S-22	22	350	0.39
204S-24	24	350	0.39
204S-27	27	400	0.45
204S-30	30	400	0.80
204S-32	32	400	0.78
204S-36	36	450	0.93
204S-38	38	450	0.93
204S-41	41	450	1.36
204S-46	46	500	2.06
204S-50	50	550	2.79

No.	S inch	l inch	Wt. lbs.
204SU-005	7/8	14	0.86
204SU-010	15/16	14	0.86
204SU-015	1 ^{1/16}	16	1.08
204SU-020	1 ^{3/16}	16	1.76
204SU-025	1 ^{1/4}	16	1.72
204SU-030	1 ^{7/16}	18	2.05
204SU-035	1 ^{1/2}	18	2.05
204SU-040	1 ^{5/8}	18	3.00
204SU-045	1 ^{13/16}	20	4.54
204SU-050	2	22	6.15

*OTHER SIZES ON REQUEST



206 Wrench, Combination

- Ringmaulschlüssel
- Clé mixte
- Llave combinada

No.	S mm	l mm	ΔΔ kg
206-6	6	90	0.02
206-7	7	100	0.03
206-8	8	105	0.03
206-9	9	115	0.05
206-10	10	125	0.05
206-11	11	135	0.07
206-12	12	140	0.09
206-13	13	150	0.10
206-14	14	160	0.13
206-15	15	165	0.14
206-16	16	175	0.15
206-17	17	180	0.17
206-18	18	195	0.21
206-19	19	205	0.23
206-20	20	205	0.25
206-21	21	230	0.27
206-22	22	245	0.30
206-23	23	245	0.36
206-24	24	265	0.41
206-25	25	290	0.58
206-26	26	290	0.58
206-27	27	290	0.58
206-28	28	320	0.63
206-30	30	320	0.63
206-32	32	335	0.79
206-34	34	350	0.92
206-36	36	350	0.93
206-38	38	360	1.24
206-41	41	370	1.46
206-46	46	405	1.68
206-50	50	420	1.92
206-55	55	435	2.32
206-60	60	465	2.59
206-65	65	470	2.88
206-70	70	480	3.39

No.	S inch	l inch	Wt. lbs.
206U-005	1/4	3 ^{9/16}	0.05
206U-010	5/16	4 ^{3/16}	0.07
206U-015	11/32	4 ^{9/16}	0.10
206U-020	3/8	4 ^{9/16}	0.10
206U-025	13/32	5 ^{3/8}	0.15
206U-030	7/16	5 ^{3/8}	0.15
206U-035	1/2	6	0.22
206U-040	9/16	6 ^{3/8}	0.29
206U-045	19/32	6 ^{3/8}	0.29
206U-050	5/8	7	0.33
206U-055	11/16	7 ^{3/16}	0.37
206U-060	3/4	8 ^{3/16}	0.51
206U-065	25/32	8 ^{3/16}	0.51
206U-070	13/16	9 ^{3/16}	0.60
206U-075	7/8	9 ^{3/4}	0.66
206U-080	15/16	10 ^{9/16}	0.90
206U-085	31/32	11 ^{9/16}	1.28
206U-090	1	11 ^{9/16}	1.28
206U-095	1 ^{1/16}	11 ^{9/16}	1.28
206U-100	1 ^{1/8}	12 ^{3/4}	1.39
206U-105	1 ^{3/16}	12 ^{3/4}	1.39
206U-110	1 ^{1/4}	13 ^{3/8}	1.74
206U-115	1 ^{5/16}	14	2.03
206U-120	1 ^{3/8}	14	2.03
206U-125	1 ^{7/16}	14	2.05
206U-130	1 ^{1/2}	14 ^{3/8}	2.73
206U-135	1 ^{9/16}	14 ^{3/4}	3.22
206U-140	1 ^{5/8}	14 ^{3/4}	3.22
206U-145	1 ^{11/16}	16 ^{3/16}	3.70
206U-155	1 ^{13/16}	16 ^{3/16}	3.70
206U-165	2	16 ^{3/4}	4.23
206U-170	2 ^{3/16}	17 ^{3/8}	5.11
206U-175	2 ^{3/8}	18 ^{9/16}	5.71
206U-180	2 ^{9/16}	18 ^{3/4}	6.35
206U-185	2 ^{5/8}	19 ^{3/16}	7.47

*ALSO AVAILABLE IN LONG VERSION

When ordering, specify:
 A=Aluminum Bronze
 B=Copper Beryllium
 Example:207F-30A
 or
 207F-30B



206Kit Combination Wrench Kit

- Ringmaulschlüssel, garnitur
- Clé mixte, jeu
- Llave combinada, juego

No.	Parts	inch/mm	Δ kg
206KIT-7	7	3/8,7/16,1/2,9/16,5/8,3/4,7/8	2.20
206KIT-9	9	6,7,8,10,13,15,17,18,19	1.23
206KIT-11	11	10,13,15,17,18,19,21,22,24,27,30	3.36
206KIT-14	14	10,11,12,13,14,15,16,17,18,19,20,21,22,24	2.97

*PLASTIC CASE INCLUDED

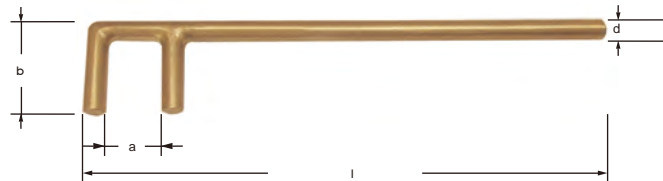

207F Valve Wheel Hook

- Ventilhaken
- Clé à valve
- Gancho girador de válvulas

No.	a mm	b mm	d mm	l mm	Δ kg	a inch	b inch	d inch	l inch	Wt. lbs.
207F-30	30	56	13	300	0.44	1 ³ / ₁₆	2 ¹ / ₄	1/2	12	0.96
207F-35	35	61	13	350	0.50	1 ³ / ₈	2 ⁷ / ₁₆	1/2	14	1.11
207F-40	40	72	16	400	0.87	1 ⁹ / ₁₆	2 ⁷ / ₈	5/8	16	1.93
207F-45	45	77	16	450	0.98	1 ³ / ₄	3 ¹ / ₁₆	5/8	18	2.15
207F-50	50	88	19	500	1.54	2	3 ¹ / ₂	3/4	20	3.39
207F-60	60	104	22	600	2.47	2 ³ / ₈	4 ¹ / ₈	7/8	24	5.44
207F-70	70	120	25	700	3.71	2 ³ / ₄	4 ³ / ₄	1	28	8.18
207F-80	80	136	28	800	5.31	3 ³ / ₁₆	5 ⁷ / ₁₆	1 ¹ / ₈	32	11.72

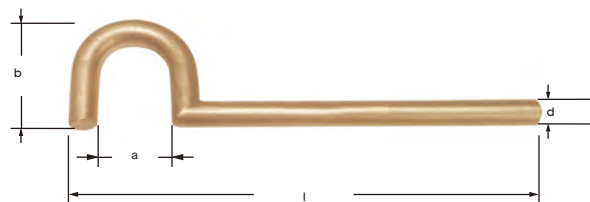

207 Wrench, Valve

- Ventilhaken
- Clé à valve
- Gancho girador de válvulas

No.	a mm	b mm	d mm	l mm	Δ kg	a inch	b inch	d inch	l inch	Wt. lbs.
207-30	30	56	13	200	0.30	1 ³ / ₁₆	2 ¹ / ₄	1/2	8	0.66
207-32	32	60	14	250	0.42	1 ¹ / ₄	2 ³ / ₈	9/16	10	0.93
207-36	36	66	15	270	0.52	1 ⁷ / ₁₆	2 ⁵ / ₈	9/16	10 ³ / ₄	1.15
207-41	41	73	16	300	0.66	1 ⁵ / ₈	2 ⁷ / ₈	5/8	12	1.46
207-50	50	86	18	320	0.92	2	3 ⁷ / ₁₆	11/16	12 ³ / ₄	2.02

When ordering, specify:

A=Aluminum Bronze

B=Copper Beryllium

Example: 207S-215A

OR

207S-215B

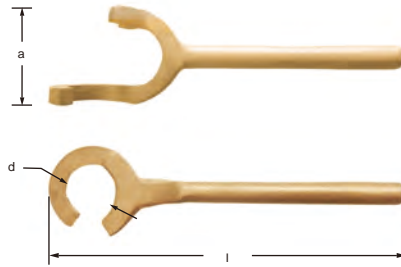

207S
Wrench, Valve Wheel
(DIN87311)

- Handradschlüssel
- Clé à volant
- Llave giradora de válvulas

No.	d mm	a mm	l mm	Δ kg	d inch	a inch	l inch	Wt. lbs.
207S-215	32	56	215	0.39	1 ¹ / ₄	2 ¹ / ₄	8 ⁹ / ₁₆	0.86
207S-290	36	56	290	1.03	1 ⁷ / ₁₆	2 ¹ / ₄	11 ⁹ / ₁₆	2.27
207S-400	48	80	400	0.86	1 ⁷ / ₈	3 ³ / ₁₆	16	1.90
207S-490	60	100	490	1.95	2 ³ / ₈	4	19 ⁹ / ₁₆	4.30
207S-800	60	110	800	5.70	2 ³ / ₈	4 ³ / ₈	32	12.57

*OTHER SIZES ON REQUEST

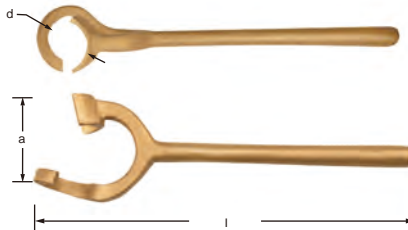

207ES
Wrench, Valve Wheel, Special

- Handradschlüssel
- Clé à volant
- Llave giradora de válvulas

No.	wheel size	d mm	a mm	l mm	Δ kg	wheel size	d inch	a inch	l inch	Wt. lbs.
207ES-215	76-178	24	56	215	0.20	3-7	15/16	2 ¹ / ₄	8 ⁹ / ₁₆	0.44

*OTHER SIZES ON REQUEST

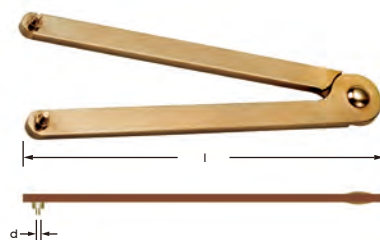

208DH
Spanner, Adjustable For
Double Hole

- Schraubenschlüssel für Doppel-Loch
- Clé ajustable pour double trous
- Llave ajustable por doble agujero

No.	d mm	l mm	Δ kg	d inch	l inch	Wt. lbs.
208DH-2.9	2.9	160	0.14	1/8	6 ³ / ₈	0.31



208S
Hook, Spanner Adjustable

- Gelenkhakenschlüssel
- Clé à ergot articulé
- Llave de gancho ajustable

No.	d mm	l mm	Δ kg	d inch	l inch	Wt. lbs.
208S-3275	32-75	250	0.21	1 ¹ / ₄ -3	8 ³ / ₁₆	0.46
208S-50120	50-120	285	0.48	2-4 ³ / ₄	11 ³ / ₈	1.06
208S-115170	115-170	310	1.21	4 ⁹ / ₁₆ -6 ³ / ₄	12 ³ / ₈	2.76

When ordering, specify:
A=Aluminum Bronze
B=Copper Beryllium
Example: 208-1214A

OR
208-1214B



208
Hook, Spanner, Fixed
(DIN1810)

- Hakenschlüssel
- Clé à ergot
- Llave de gancho

No.	d mm	l mm	ΔΔ kg	d inch	l inch	Wt. lbs.
208-1214	12/14	103	0.03	7/16-9/16	4 ¹ / ₈	0.07
208-1618	16/18	104	0.03	5/8-11/16	4 ¹ / ₈	0.07
208-1620	16/20	104	0.03	5/8-3/4	4 ¹ / ₈	0.07
208-2022	20/22	105	0.03	3/4-7/8	4 ³ / ₁₆	0.07
208-2528	25/28	126	0.05	1-1 ¹ / ₈	5 ³ / ₆₄	0.11
208-3032	30/32	128	0.05	1 ³ / ₁₆ -1 ¹ / ₄	5 ¹ / ₈	0.11
208-3436	34/36	160	0.10	1 ³ / ₈ -1 ⁷ / ₁₆	6 ³ / ₈	0.22
208-4042	40/42	161	0.10	1 ⁹ / ₁₆ -1 ¹¹ / ₁₆	6 ⁷ / ₁₆	0.22
208-4550	45/50	193	0.18	1 ³ / ₄ -2	7 ¹¹ / ₁₆	0.40
208-5255	52/55	195	0.18	2 ¹ / ₁₆ -2 ³ / ₁₆	7 ³ / ₄	0.40
208-5862	58/62	227	0.29	2 ⁵ / ₁₆ -2 ⁷ / ₁₆	9 ¹ / ₁₆	0.64
208-6875	68/75	230	0.29	2 ¹¹ / ₁₆ -3	9 ³ / ₁₆	0.64
208-8090	80/90	266	0.45	3 ³ / ₁₆ -3 ⁹ / ₁₆	10 ⁵ / ₈	0.99
208-95100	95/100	271	0.44	3 ³ / ₄ -4	10 ¹³ / ₁₆	0.97
208-110115	110/115	315	0.82	4 ³ / ₈ -4 ⁹ / ₁₆	12 ⁹ / ₁₆	1.81
208-120130	120/130	319	0.82	4 ³ / ₄ -5 ³ / ₁₆	12 ³ / ₄	1.81
208-135145	135/145	363	1.32	5 ³ / ₈ -5 ³ / ₄	14 ¹ / ₂	2.91

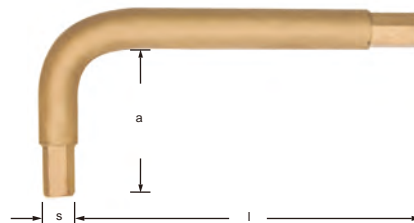

209
Wrench, Allen / Hex Key
(DIN911)

Copper Beryllium (CuBe) only

- Sechskant-Winkelschraubendreher (inbus)
- Clé mâle pour vis creuse à 6 pans
- Llaveallen hexagonal

No.	s mm	a mm	l mm	ΔΔ kg	No.	s inch	a inch	l inch	wt. lbs.
209-1.5	1.5	14	45	0.01	209U-005	1/16	9/16	1 ³ / ₄	0.01
209-2	2	16	50	0.01	209U-010	5/64	5/8	2	0.01
209-2.5	2.5	18	56	0.01	209U-015	3/32	11/16	2 ¹ / ₄	0.01
209-3	3	20	63	0.01	209U-020	1/8	3/4	2 ¹ / ₂	0.02
209-4	4	25	70	0.01	209U-025	9/64	1	2 ³ / ₄	0.04
209-5	5	28	80	0.02	209U-030	5/32	1	2 ³ / ₄	0.03
209-6	6	32	90	0.04	209U-035	3/16	1 ¹ / ₈	3 ³ / ₁₆	0.05
209-7	7	34	95	0.05	209U-040	7/32	1 ¹ / ₄	3 ⁹ / ₁₆	0.08
209-8	8	36	100	0.08	209U-045	1/4	1 ³ / ₈	3 ³ / ₄	0.11
209-10	10	40	112	0.13	209U-050	5/16	1 ⁷ / ₁₆	4	0.19
209-12	12	45	125	0.21	209U-060	7/16	1 ³ / ₄	5	0.47
209-14	14	56	140	0.35	209U-065	1/2	2 ¹ / ₄	5 ⁹ / ₁₆	0.77
209-17	17	63	160	0.56	209U-070	9/16	2 ¹ / ₄	5 ⁹ / ₁₆	0.77
209-19	19	70	180	0.76	209U-085	3/4	2 ³ / ₄	7 ³ / ₁₆	1.68
209-22	22	80	200	1.25	209U-090	1	3 ³ / ₁₆	8	2.76
209-24	24	90	224	1.63	209U-095	15/16	3 ⁹ / ₁₆	8 ¹⁵ / ₁₆	3.59
209-27	27	100	250	2.37	209U-100	1 ¹ / ₁₆	4	10	5.22
209-32	32	125	315	4.22	209U-105	1 ¹ / ₈	5	12 ⁹ / ₁₆	9.30
209-36	36	140	355	5.82	209U-110	1 ¹ / ₄	5	12 ⁹ / ₁₆	9.30

When ordering, specify:

A=Aluminum Bronze

B=Copper Beryllium

Example:216L-22A

or

216L-22B

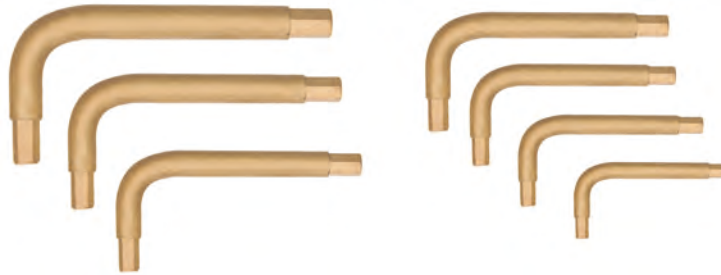

209Kit Allen Wrench Kit (Pouch included)

Copper Beryllium (CuBe only)

- Sechskant-Winkelschraubendreher (inbus)
- Clé mâle pour vis creuse à 6 pans
- Llave hexagonal, allen

No.	Parts	s mm	Δ kg
209K-7B	7	1.5,2,2.5,3,4,5,6	0.13
209K-9B	9	1.5,2,2.5,3,4,5,6,8,10	0.53



209L Wrench, Allen / Hex Key Ball Point, Long Type

Copper Beryllium (CuBe) only

- Sechskant - Winkelschraubendreher, lang, mit Kugelkopf
- Clé mâle longue à tête sphérique
- Llave hexagonal, larga, cabeza esférica

No.	s mm	a mm	l mm	Δ kg
209L-1.5	1.5	14	88	0.01
209L-2	2	16	99	0.01
209L-2.5	2.5	18	109	0.01
209L-3	3	20	125	0.01
209L-4	4	25	139	0.03
209L-5	5	28	155	0.04
209L-6	6	32	176	0.07
209L-7	7	34	188	0.09
209L-8	8	36	201	0.14
209L-10	10	40	228	0.25
209L-12	12	45	258	0.37
209L-14	14	56	276	0.63
209L-17	17	63	299	0.92

No.	s inch	a inch	l inch	Wt. lbs.
209LU-005	1/16	9/16	3 1/2	0.01
209LU-010	5/64	5/8	3 15/16	0.01
209LU-015	3/32	11/16	4 3/8	0.02
209LU-020	1/8	3/4	5	0.03
209LU-025	5/32	1 1/8	6 3/16	0.09
209LU-030	3/16	1 1/4	7	0.15
209LU-035	7/32	1 3/8	7 1/2	0.20
209LU-040	1/4	1 7/16	8	0.32
209LU-045	5/16	1 3/4	10 5/16	0.82
209LU-048	3/8	2 1/4	11	1.39
209LU-050	7/16	1 3/4	10 5/16	0.82
209LU-055	1/2	2 1/4	11	1.39



216 Extension For Box Wrench

- Aufsteckrohr für Ringzugschlüssel
- Tube levier pour clé polygonale
- Extension para la llave de cajon

No.	d mm	l mm	Δ kg	d inch	l inch	Wt. lbs.
216-22	22	600	1.10	7/8	24	2.43
216-25	25	750	1.88	1	30	4.14
216-30	30	850	2.72	1 3/16	34	6.00

When ordering, specify:
 A=Aluminum Bronze
 B=Copper Beryllium
 Example:215-30A
 or
 215-30B

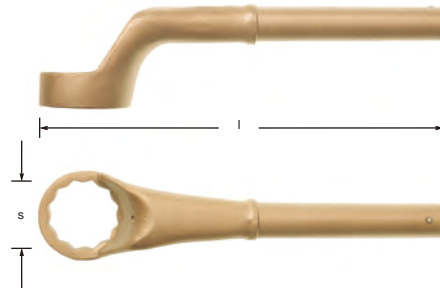

215 Wrench, Box, For Extension

- Ringzugschlüssel
- Clé polygonale à extension
- Llave de cajón para extensión

No.	s mm	l mm	Δ kg	No.	s inch	l inch	Wt. lbs.
215-30	30	200	0.92	215U-005	1 ³ / ₁₆	8	2.03
215-32	32	235	0.97	215U-010	1 ¹ / ₄	9 ³ / ₈	2.14
215-33	33	235	0.97	215U-015	1 ⁵ / ₁₆	9 ³ / ₈	2.14
215-34	34	235	0.97	215U-020	1 ³ / ₈	9 ³ / ₈	2.14
215-35	35	245	1.03	215U-025	1 ⁷ / ₁₆	9 ³ / ₄	2.27
215-36	36	245	1.03	215U-030	1 ¹ / ₂	10	2.51
215-37	37	250	1.14	215U-040	1 ⁵ / ₈	10 ⁹ / ₁₆	2.78
215-38	38	250	1.14	215U-045	1 ¹¹ / ₁₆	10 ⁹ / ₁₆	2.78
215-41	41	265	1.26	215U-055	1 ¹³ / ₁₆	11 ³ / ₁₆	3.53
215-42	42	265	1.26	215U-060	1 ⁷ / ₈	11 ³ / ₁₆	3.53
215-46	46	280	1.60	215U-065	2	11 ³ / ₁₆	3.90
215-47	47	280	1.60	215U-070	2 ¹ / ₁₆	11 ³ / ₁₆	3.90
215-50	50	280	1.77	215U-080	2 ³ / ₁₆	11 ⁹ / ₁₆	4.30
215-52	52	280	1.77	215U-090	2 ⁵ / ₁₆	13 ³ / ₁₆	6.39
215-55	55	290	1.95	215U-095	2 ³ / ₈	13 ³ / ₁₆	6.39
215-58	58	330	2.90	215U-110	2 ⁹ / ₁₆	14	6.83
215-60	60	330	2.90	215U-115	2 ⁵ / ₈	14 ³ / ₈	7.72
215-65	65	350	3.10	215U-120	2 ³ / ₄	14 ³ / ₈	7.72
215-70	70	360	3.50	215U-125	2 ³ / ₁₆	14 ³ / ₈	7.72



501 Wrench, Adjustable End

- Röllgabelschlüssel
- Clé à molette
- Llave de cabeza ajustable

No.	s max mm	l mm	Δ kg	s max inch	l inch	Wt. lbs.
501-6	19	150	0.13	3/4	6	0.29
501-8	24	200	0.28	15/16	8	0.62
501-10	28	250	0.48	1 ¹ / ₈	10	1.06
501-12	34	300	0.76	1 ³ / ₈	12	1.68
501-15	45	375	1.42	1 ³ / ₄	15	3.13
501-18	55	450	2.81	2 ³ / ₁₆	18	6.19
501-24	60	600	4.93	2 ³ / ₈	24	10.87

When ordering, specify:

A=Aluminum Bronze

B=Copper Beryllium

Example:502-6A

or

502-6B

502 Wrench, Pipe (American Type)

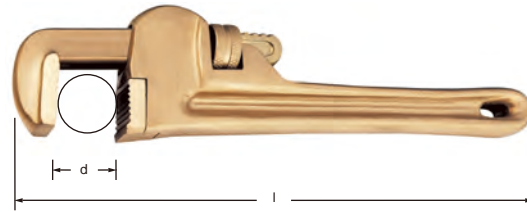

- Verstellbare Rohrschlüssel
- Clé serre-tube
- Llave ajustable para tubos

No.	d max mm	l mm	Δ kg	d max inch	l inch	Wt. lbs.
502-6	20	150	0.30	3/4	6	0.66
502-8	25	200	0.47	1	8	1.04
502-10	30	250	1.02	1 ³ / ₁₆	10	2.25
502-12	40	300	1.48	1 ⁹ / ₁₆	12	3.26
502-14	50	350	1.63	2	14	3.59
502-18	60	450	2.85	2 ³ / ₈	18	6.28
502-24	75	600	4.84	3	24	10.67
502-36	85	900	7.79	3 ³ / ₈	36	17.17
502-48	110	1200	13.57	4 ³ / ₈	48	29.92

503 Wrench, Monkey

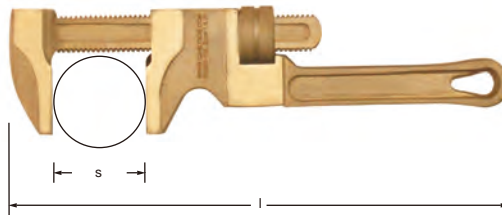

- Verstellbarer Schraubenschlüssel
- Clé anglaise
- Llave inglesa

No.	s max mm	l mm	Δ kg	s max inch	l inch	Wt. lbs.
503-10	48	254	0.83	1 ⁷ / ₈	10 ¹ / ₈	1.83
503-15	70	380	2.19	2 ³ / ₄	15 ³ / ₁₆	4.83

600 Wrench, Chain Pipe



- Kettenrohrzange
- Serre-tube à chaîne
- Llave encadenadora de tubos

No.	d max mm	l mm	Δ kg	d max inch	l inch	Wt. lbs.
600-2	50	600	1.60	2	24	3.53
600-4	100	600	1.81	4	24	3.99
600-6	150	600	1.99	6	24	4.39

*AVAILABLE IN HEAVY DUTY VERSION

When ordering, specify:
A=Aluminum Bronze
B=Copper Beryllium
Example: 1503AA-3A

or
1503AA-3B

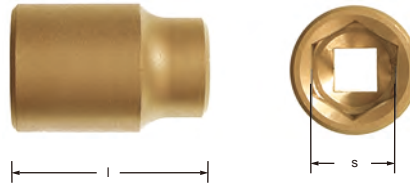

1503AA Socket 1/4" Drive

- Steckschlüsseinsatz, 1/4" drive
- Douilles, 1/4" drive
- Cubos, 1/4" drive

No.	s mm	l mm	Δ kg	No.	s inch	l inch	Wt. lbs.
1503AA-3	3	23	0.01	1503AAU-005	1/8	7/8	0.02
1503AA-4	4	23	0.01	1503AAU-010	3/16	7/8	0.02
1503AA-5	5	23	0.01	1503AAU-012	7/32	7/8	0.02
1503AA-6	6	23	0.01	1503AAU-015	1/4	7/8	0.02
1503AA-7	7	23	0.01	1503AAU-017	9/32	7/8	0.04
1503AA-8	8	23	0.02	1503AAU-020	5/16	7/8	0.04
1503AA-9	9	23	0.02	1503AAU-022	11/32	7/8	0.04
1503AA-10	10	23	0.02	1503AAU-025	3/8	7/8	0.04
1503AA-11	11	25	0.02	1503AAU-030	7/16	1	0.04
1503AA-12	12	25	0.03	1503AAU-035	1/2	1	0.07
1503AA-13	13	25	0.03	1503AAU-040	9/16	1	0.07
1503AA-14	14	25	0.03				

1520-Kit Sockets 1/4" Drive Kit (Case included)

- Steckschlüsseinsätze 1/4" drive-14-Stücke Garnitur
- Douilles 1/4" drive-14-pièces jeu
- Cubos 1/4" drive-14-piezas juego

No.	s mm	Accessoires	Δ kg
1520-14	4,5,6,7,8,9,10,11,12,13	Ratchet Sliding Bar 100mm Extension Bar Hinged Handle	0.96

*PLASTIC CASE INCLUDED

1503A Socket 3/8" Drive

- Steckschlüsseinsatz, 3/8" drive
- Douilles, 3/8" drive
- Cubos, 3/8" drive

No.	s mm	l mm	Δ kg	No.	s inch	l inch	Wt. lbs.
1503A-6	6	31	0.02	1503AU-005	1/4	1/4	0.04
1503A-7	7	31	0.02	1503AU-010	5/16	1/4	0.04
1503A-8	8	31	0.02	1503AU-015	3/8	1/4	0.04
1503A-9	9	31	0.02	1503AU-020	7/16	1/4	0.09
1503A-10	10	31	0.03	1503AU-025	1/2	1/4	0.09
1503A-11	11	31	0.04	1503AU-030	9/16	1/4	0.11
1503A-12	12	31	0.04	1503AU-035	5/8	3/8	0.13
1503A-13	13	31	0.04	1503AU-040	11/16	3/8	0.13
1503A-14	14	31	0.05	1503AU-045	3/4	3/8	0.15
1503A-15	15	34	0.06	1503AU-050	13/16	1/2	0.18
1503A-16	16	34	0.06	1503AU-055	7/8	1/2	0.20
1503A-17	17	34	0.06				
1503A-18	18	34	0.07				
1503A-19	19	34	0.07				
1503A-20	20	38	0.08				
1503A-21	21	38	0.08				
1503A-22	22	38	0.09				

When ordering, specify:

A=Aluminum Bronze

B=Copper Beryllium

Example:1503B-6A

or

1503B-6B

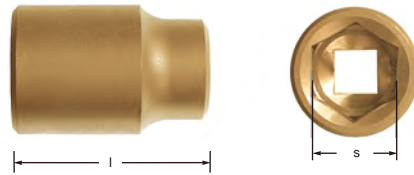

1530B Socket 1/2" Drive

- Steckschlüsseinsatz, 1/2" drive
- Douilles, 1/2" drive
- Cubos, 1/2" drive

No.	s mm	l mm	kg	No.	s inch	l inch	Wt. lbs.
1503B-6	6	38	0.07	1503BU-005	1/4	1 1/2	0.15
1503B-7	7	38	0.07	1503BU-010	5/16	1 1/2	0.18
1503B-8	8	38	0.08	1503BU-015	3/8	1 1/2	0.18
1503B-9	9	38	0.08	1503BU-020	7/16	1 1/2	0.18
1503B-10	10	38	0.08	1503BU-025	1/2	1 1/2	0.18
1503B-11	11	38	0.08	1503BU-030	9/16	1 1/2	0.18
1503B-12	12	38	0.08	1503BU-035	5/8	1 1/2	0.20
1503B-13	13	38	0.08	1503BU-040	11/16	1 1/2	0.22
1503B-14	14	38	0.08	1503BU-045	3/4	1 1/2	0.24
1503B-15	15	38	0.08	1503BU-047	25/32	1 1/2	0.24
1503B-16	16	38	0.09	1503BU-050	13/16	1 1/2	0.24
1503B-17	17	38	0.10	1503BU-055	7/8	1 1/2	0.26
1503B-18	18	38	0.11	1503BU-060	15/16	1 1/2	0.31
1503B-19	19	38	0.11	1503BU-065	1	1 1/2	0.31
1503B-20	20	38	0.11	1503BU-070	1 1/16	1 9/16	0.40
1503B-21	21	38	0.11	1503BU-075	1/8	1 9/16	0.44
1503B-22	22	38	0.12	1503BU-080	1 3/16	1 11/16	0.46
1503B-23	23	38	0.13	1503BU-085	1 1/4	1 11/16	0.51
1503B-24	24	38	0.14	1503BU-090	1 5/16	1 11/16	0.55
1503B-25	25	38	0.14	1503BU-095	1 3/8	1 11/16	0.60
1503B-26	26	38	0.16	1503BU-100	1 7/16	1 11/16	0.64
1503B-27	27	40	0.18	1503BU-110	1 1/2	1 11/16	0.69
1503B-28	28	40	0.20				
1503B-29	29	40	0.20				
1503B-30	30	42	0.21				
1503B-31	31	42	0.23				
1503B-32	32	42	0.23				

1530-Kit Sockets 1/2" Drive Kit (Box included)

- Steckschlüsseinsätze 1/2" drive-27-Stücke Garnitur
- Douilles 1/2" drive-27-pièces jeu
- Cubos 1/2" drive-27-piezas juego

No.	s mm	Accessoires	kg
1530-27	8,10,11,12,13,14,15,16,17,18,19, 20,21,22,23,24,26,27,28,30,32	Ratchet Spanner Hinged Handle Extension Bar100mm Extension Bar250mm Sliding Tee Unversal Joint	7.16

*PLASTIC CASE INCLUDED

No.	s mm	Accessoires	kg
1530-19	5/16, 3/8, 7/16, 1/2, 9/16, 5/8, 11/16, 3/4, 13/16, 7/8, 15/16, 1, 1-1/16, 1-1/8, 1-1/4	Ratchet Sliding Handle Hinged Handle Extension Bar	4.83

*PLASTIC CASE INCLUDED

When ordering, specify:
 A=Aluminum Bronze
 B=Copper Beryllium
 Example:1503C-19A
 or
 1503C-19B

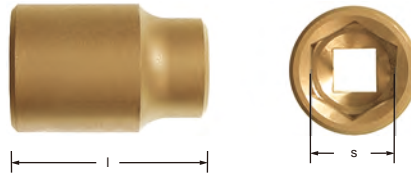

**1503C
 Socket 3/4" Drive**

- Steckschlüsseinsatz, 3/4" drive
- Douilles, 3/4" drive
- Cubos, 3/4" drive

No.	s mm	l mm	ΔΔ kg	No.	s inch	l inch	Wt. lbs.
1503C-19	19	49	0.24	1503CU-005	3/4	1 ^{15/16}	0.53
1503C-20	20	49	0.24	1503CU-010	13/16	1 ^{15/16}	0.53
1503C-21	21	49	0.24	1503CU-015	7/8	1 ^{5/16}	0.55
1503C-22	22	49	0.25	1503CU-020	15/16	1 ^{15/16}	0.57
1503C-23	23	49	0.26	1503CU-025	1	1 ^{15/16}	0.57
1503C-24	24	49	0.26	1503CU-030	1 ^{1/16}	2	0.57
1503C-25	25	49	0.26	1503CU-035	1 ^{1/8}	2	0.57
1503C-26	26	50	0.26	1503CU-040	1 ^{3/16}	2	0.62
1503C-27	27	50	0.26	1503CU-045	1 ^{1/4}	2 ^{1/8}	0.68
1503C-28	28	50	0.26	1503CU-050	1 ^{5/16}	2 ^{1/8}	0.71
1503C-29	29	50	0.28	1503CU-055	1 ^{3/8}	2 ^{1/8}	0.84
1503C-30	30	50	0.28	1503CU-060	1 ^{7/16}	2 ^{1/4}	1.01
1503C-31	31	54	0.31	1503CU-065	1 ^{1/2}	2 ^{1/4}	1.12
1503C-32	32	54	0.32	1503CU-070	1 ^{9/16}	2 ^{1/4}	1.28
1503C-34	34	54	0.38	1503CU-075	1 ^{5/8}	2 ^{3/8}	1.37
1503C-35	35	54	0.46	1503CU-080	1 ^{11/16}	2 ^{3/8}	1.37
1503C-36	36	56	0.46	1503CU-085	1 ^{3/4}	2 ^{5/8}	1.50
1503C-37	37	56	0.51	1503CU-090	1 ^{13/16}	2 ^{5/8}	1.81
1503C-38	38	56	0.51	1503CU-095	1 ^{7/8}	2 ^{5/8}	1.85
1503C-39	39	56	0.58	1503CU-100	1 ^{15/16}	2 ^{11/16}	1.98
1503C-40	40	60	0.62	1503CU-105	2	2 ^{11/16}	2.03
1503C-41	41	60	0.62				
1503C-42	42	60	0.62				
1503C-43	43	60	0.68				
1503C-44	44	66	0.68				
1503C-45	45	66	0.80				
1503C-46	46	66	0.82				
1503C-47	47	66	0.84				
1503C-48	48	68	0.87				
1503C-49	49	68	0.90				
1503C-50	50	68	0.92				

**1540-Kit
 Sockets 3/4" Drive Kit
 (Box included)**

- Steckschlüsseinsätze 3/4" drive-13-Stücke Garnitur
- Douilles 3/4" drive-13-pièces jeu
- Cubos 3/4" drive-13-piezas juego

No.	s mm	Accessoires	ΔΔ kg
1540-13	22,24,27,30,32,36,41,46,50	Ratchet Sliding Bar Extension Bar100mm Hinged Handle	8.57

*PLASTIC CASE INCLUDED

When ordering, specify:

A=Aluminum Bronze

B=Copper Beryllium

Example:1503D-32A

or

1503D-32B

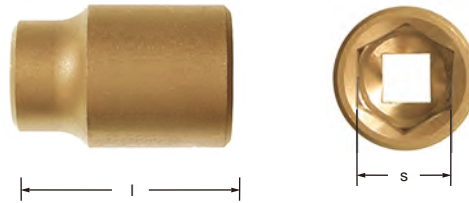

1503D Socket 1" Drive

- Steckschlüsseinsatz, 1" drive
- Douilles, 1" drive
- Cubos, 1" drive

No.	s mm	l mm	Δ kg	No.	s inch	l inch	Wt. lbs.
1503D-32	32	70	0.52	1503DU-020	1 ^{1/4}	2 ^{3/4}	1.15
1503D-36	36	70	0.66	1503DU-035	1 ^{7/16}	2 ^{3/4}	1.46
1503D-41	41	70	0.77	1503DU-045	1 ^{5/8}	2 ^{3/4}	1.70
1503D-46	46	70	0.89	1503DU-060	1 ^{13/16}	2 ^{3/4}	1.96
1503D-50	50	70	0.96	1503DU-075	2	2 ^{3/4}	2.12
1503D-55	55	70	1.22	1503DU-090	2 ^{3/16}	2 ^{15/16}	2.69
1503D-60	60	78	1.42	1503DU-095	2 ^{1/4}	3 ^{1/8}	3.13
1503D-65	65	78	1.68	1503DU-115	2 ^{1/2}	3 ^{1/8}	3.70
1503D-70	70	78	2.10	1503DU-130	2 ^{3/4}	3 ^{1/8}	4.63
1503D-75	75	78	2.36	1503DU-145	3	3 ^{1/8}	5.20
1503D-80	80	78	2.68	1503DU-153	3 ^{3/16}	3 ^{1/8}	5.91

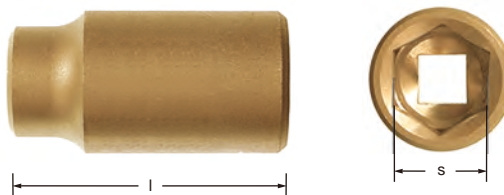

1610 Socket, Deep, 1/4" Drive

- Steckschlüsseinsatz, 1/4" drive, lang
- Douilles, 1/4" drive, longues
- Cubos, 1/4" drive, largo

No.	s mm	l mm	Δ kg	No.	s inch	l inch	Wt. lbs.
1610-3	3	50	0.03	1610U-005	1/8	2	0.06
1610-4	4	50	0.03	1610U-010	3/16	2	0.06
1610-4.5	4.5	50	0.03	1610U-012	7/32	2	0.06
1610-5	5	50	0.03	1610U-015	7/32	2	0.06
1610-5.5	5.5	50	0.03	1610U-017	9/32	2	0.07
1610-6	6	50	0.03	1610U-020	1/4	2	0.08
1610-7	7	50	0.03	1610U-022	11/32	2	0.09
1610-8	8	50	0.03	1610U-025	9/32	2	0.09
1610-9	9	50	0.04	1610U-030	5/16	2	0.12
1610-10	10	50	0.04	1610U-035	11/32	2	0.16
1610-11	11	50	0.06	1610U-040	3/8	2	0.20
1610-12	12	50	0.07	1610U-045	7/16	2	0.16
1610-13	13	50	0.07	1610U-050	1/2	2	0.16
1610-14	14	50	0.09	1610U-055	9/16	2	0.20

When ordering, specify:
A=Aluminum Bronze
B=Copper Beryllium
 Example: 1620-6A
 or
 1620-6B

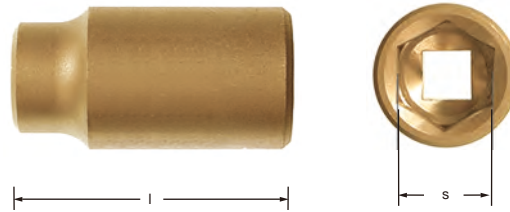

1620 Socket, Deep, 3/8" Drive

- Steckschlüsseinsatz, 3/8" drive, lang
- Douilles, 3/8" drive, longues
- Cubos, 3/8" drive, largo

No.	s mm	l mm	⚖ kg
1620-6	6	60	0.04
1620-7	7	60	0.04
1620-8	8	60	0.04
1620-9	9	65	0.04
1620-10	10	65	0.08
1620-11	11	65	0.08
1620-12	12	65	0.08
1620-13	13	65	0.08
1620-14	14	65	0.10
1620-15	15	70	0.12
1620-16	16	70	0.12
1620-17	17	70	0.12
1620-18	18	70	0.14
1620-19	19	70	0.14
1620-20	20	70	0.16
1620-21	21	70	0.16
1620-22	22	70	0.18
1620-23	23	70	0.20
1620-24	24	70	0.20
1620-25	25	70	0.20

No.	s inch	l inch	Wt. lbs.
1620U-005	1/4	2	0.09
1620U-010	5/16	2	0.09
1620U-015	3/8	2	0.09
1620U-020	7/16	2	0.09
1620U-025	1/2	2	0.09
1620U-030	9/16	3	0.26
1620U-035	5/8	3	0.26
1620U-040	11/16	3	0.26
1620U-045	3/4	3	0.26
1620U-050	13/16	3	0.35
1620U-055	7/8	3	0.40
1620U-060	15/16	3	0.40
1620U-065	1	3	0.40

1630 Socket, Deep, 1/2" Drive

- Steckschlüsseinsatz, 1/2" drive, lang
- Douilles, 1/2" drive, longues
- Cubos, 1/2" drive, largo

No.	s mm	l mm	⚖ kg
1630-6	6	85	0.14
1630-7	7	85	0.14
1630-8	8	85	0.16
1630-9	9	85	0.16
1630-10	10	85	0.16
1630-11	11	85	0.16
1630-12	12	85	0.16
1630-13	13	85	0.16
1630-14	14	85	0.16
1630-15	15	85	0.16
1630-16	16	85	0.18
1630-17	17	85	0.20
1630-18	18	85	0.22
1630-19	19	85	0.22
1630-20	20	85	0.22
1630-21	21	85	0.22
1630-22	22	85	0.24
1630-23	23	85	0.26
1630-24	24	85	0.28
1630-25	25	85	0.28
1630-26	26	85	0.32
1630-27	27	85	0.36
1630-28	28	85	0.40
1630-29	29	85	0.40
1630-30	30	85	0.42
1630-32	32	85	0.46
1630-36	36	85	0.46

No.	s inch	l inch	Wt. lbs.
1630U-005	1/4	3	0.31
1630U-010	5/16	3	0.35
1630U-015	3/8	3	0.35
1630U-020	7/16	3	0.35
1630U-025	1/2	3	0.35
1630U-030	9/16	3	0.35
1630U-032	19/32	3	0.35
1630U-035	5/8	3	0.40
1630U-040	11/16	3	0.44
1630U-045	3/4	3	0.49
1630U-047	25/32	3	0.49
1630U-050	13/16	3	0.49
1630U-055	7/8	3	0.53
1630U-060	15/16	3	0.62
1630U-065	1	3	0.62
1630U-070	1 1/16	3	0.79
1630U-075	1 1/8	3	0.88
1630U-080	1 3/16	3	0.93
1630U-085	1 1/4	3	1.01
1630U-090	1 5/16	3	1.01
1630U-095	1 3/8	3	1.01
1630U-100	1 7/16	3	1.01
1630U-110	1 1/2	3	1.10
1630U-115	1 9/16	3	1.10
1630U-120	1 5/8	3	1.10

When ordering, specify:

A=Aluminum Bronze

B=Copper Beryllium

Example:1640-19A

or

1640-19B

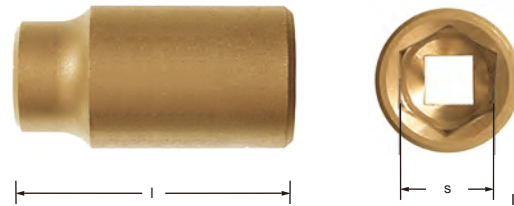

1640 Socket, Deep, 3/4" Drive

- Steckschlüsseinsatz, 3/4" drive, lang
- Douilles, 3/4" drive, longues
- Cubos, 3/4" drive, largo

No.	s mm	l mm	Δ kg
1640-19	19	90	0.48
1640-20	20	90	0.48
1640-21	21	90	0.48
1640-22	22	90	0.50
1640-23	23	90	0.52
1640-24	24	90	0.52
1640-25	25	90	0.52
1640-26	26	90	0.52
1640-27	27	90	0.52
1640-28	28	90	0.52
1640-29	29	90	0.56
1640-30	30	90	0.56
1640-31	31	90	0.62
1640-32	32	90	0.64
1640-33	33	90	0.76
1640-34	34	90	0.76
1640-35	35	100	0.92
1640-36	36	100	0.92
1640-37	37	100	1.02
1640-38	38	100	1.02
1640-39	39	100	1.16
1640-40	40	100	1.24
1640-41	41	100	1.24
1640-42	42	100	1.24
1640-43	43	100	1.36
1640-44	44	100	1.36
1640-45	45	100	1.60
1640-46	46	100	1.64
1640-47	47	100	1.68
1640-48	48	100	1.74
1640-49	49	100	1.80
1640-50	50	100	1.84
1640-52	52	100	1.08
1640-55	55	100	1.30
1640-60	60	100	2.00

No.	s inch	l inch	Wt. lbs.
1640U-005	3/4	4	1.05
1640U-010	13/16	4	1.05
1640U-015	7/8	4	1.10
1640U-020	15/16	4	1.14
1640U-025	1	4	1.14
1640U-030	1 ^{1/16}	4	1.14
1640U-035	1 ^{1/8}	4	1.14
1640U-040	1 ^{3/16}	4	1.24
1640U-045	1 ^{1/4}	4	1.41
1640U-050	1 ^{5/16}	4	1.68
1640U-055	1 ^{3/8}	4	2.03
1640U-060	1 ^{7/16}	4	2.03
1640U-065	1 ^{1/2}	4	2.25
1640U-070	1 ^{9/16}	4	2.56
1640U-075	1 ^{5/8}	4	2.73
1640U-080	1 ^{11/16}	4	3.00
1640U-085	1 ^{3/4}	4	3.00
1640U-090	1 ^{13/16}	4	3.62
1640U-095	1 ^{7/8}	4	3.71
1640U-100	1 ^{15/16}	4	3.97
1640U-105	2	4	4.06
1640U-110	2 ^{1/16}	4	4.06
1640U-115	2 ^{1/8}	4	2.87
1640U-120	2 ^{3/16}	4	2.87
1640U-125	2 ^{1/4}	4	4.42
1640U-130	2 ^{5/16}	4	4.42
1640U-135	2 ^{3/8}	4	4.42

When ordering, specify:
A=Aluminum Bronze
B=Copper Beryllium
 Example:1650-32A
 or
 1650-32B

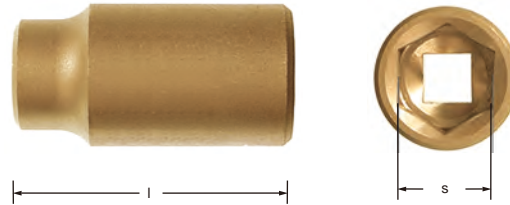

**1650
 Socket, Deep, 1" Drive**

- Steckschlüsseinsatz, 1" drive, lang
- Douilles, 1" drive, longues
- Cubos, 1" drive, largo

No.	S mm	l mm	Wt. kg
1650-32	32	150	1.04
1650-36	36	150	1.32
1650-41	41	150	1.54
1650-46	46	150	1.78
1650-50	50	150	1.92
1650-55	55	150	2.44
1650-60	60	150	2.84
1650-65	65	150	3.36
1650-70	70	150	4.20
1650-75	75	150	4.72
1650-80	80	150	5.36

No.	S inch	l inch	Wt. lbs.
1650U-005	1 ¹ / ₆	6	2.30
1650U-010	1 ¹ / ₈	6	3.30
1650U-015	1 ³ / ₁₆	6	2.30
1650U-020	1 ¹ / ₄	6	2.30
1650U-025	1 ⁵ / ₆	6	2.30
1650U-030	1 ³ / ₈	6	2.91
1650U-035	1 ⁷ / ₁₆	6	2.91
1650U-040	1 ¹ / ₂	6	2.91
1650U-045	1 ⁵ / ₈	6	3.40
1650U-050	1 ¹¹ / ₁₆	6	3.40
1650U-055	1 ³ / ₄	6	3.40
1650U-060	1 ¹³ / ₁₆	6	3.93
1650U-065	1 ⁷ / ₈	6	3.93
1650U-070	1 ¹⁵ / ₁₆	6	4.24
1650U-075	2	6	4.24
1650U-080	2 ¹ / ₁₆	6	4.24
1650U-085	2 ¹ / ₈	6	5.39
1650U-090	2 ³ / ₁₆	6	5.39
1650U-095	2 ¹ / ₄	6	5.39
1650U-100	2 ⁵ / ₁₆	6	6.27
1650U-105	2 ³ / ₈	6	6.27
1650U-110	2 ⁷ / ₁₆	6	6.27
1650U-115	2 ¹ / ₂	6	6.27
1650U-120	2 ⁹ / ₁₆	6	7.42
1650U-125	2 ⁵ / ₈	6	7.42
1650U-130	2 ³ / ₄	6	9.27
1650U-135	2 ¹³ / ₁₆	6	9.27



When ordering, specify:

A=Aluminum Bronze

B=Copper Beryllium

Example:1504-AA100A

or

1504-AA100B



1504 Bar Extension

- Verlängerung
- Rallonge
- Barra de extension

No.	a inch	l mm	kg	l inch	Wt. lbs.
1504-AA100	1/4	100	0.05	4	0.12
1504-AA200	1/4	200	0.10	8	0.21
1504-A75	3/8	75	0.07	3	0.15
1504-A150	3/8	150	0.15	6	0.33
1504-B100	1/2	100	0.26	4	0.57
1504-B200	1/2	200	0.41	8	0.90
1504-B250	1/2	250	0.48	10	1.06
1504-C100	3/4	100	0.58	4	1.28
1504-C200	3/4	200	0.96	8	2.12
1504-C250	3/4	250	1.14	10	2.51
1504-D100	1	100	1.00	4	2.20
1504-D250	1	250	1.94	10	4.28

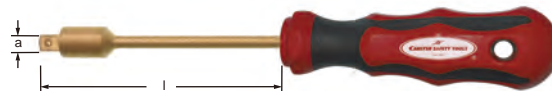

1504S Driver Handle

- Steckschlüsseldreher
- Tourne-douille
- Tornero de cubos

No.	a inch	l mm	kg	l inch	Wt. lbs.
1504S-AA	1/4	70	0.03	2 ^{3/4}	0.06
1504S-A	3/8	115	0.09	4 ^{9/16}	0.20



1506 Wrench Handle, Hinged

- Gelenkgriff
- Poignée articulée
- Mango de cabeza articulada

No.	a inch	l mm	kg	l inch	Wt. lbs.
1506-AA	1/4	145	0.13	5 ^{3/4}	0.29
1506-A	3/8	200	0.22	8	0.49
1506-B	1/2	270	0.56	10 ^{3/4}	1.23
1506-BL	1/2	360	0.73	14 ^{3/8}	1.61
1506-C	3/4	360	1.20	14 ^{3/8}	2.65
1506-D	1	360	1.87	14 ^{3/8}	4.12

When ordering, specify:
 A=Aluminum Bronze
 B=Copper Beryllium
 Example:1507-AAA
 or
 1507-AAB



1507 Universal Joint

- Kardangelen
- Cardan universel
- Conexión universal

No.	a inch	Δ kg	Wt. lbs.
1507-AA	1/4	0.03	0.07
1507-A	3/8	0.08	0.18
1507-B	1/2	0.16	0.35
1507-C	3/4	0.57	1.26
1507-D	1	1.10	2.43

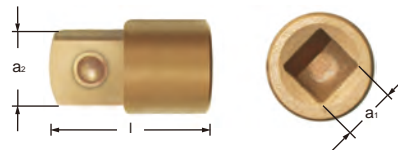

1509 Adapter / Converter

- Übergangsteil
- Réducteur pour cliquet
- Adaptador para trinquete

No.	a ₁ inch	a ₂ inch	l mm	Δ kg	l inch	Wt. lbs.
1509-AAA	1/4	3/8	25	0.10	1	0.22
1509-AAA	3/8	1/4	39	0.10	1 ^{1/8}	0.22
1509-AB	3/8	1/2	35	0.10	1 ^{7/16}	0.22
1509-BA	1/2	3/8	40	0.10	1 ^{9/16}	0.22
1509-BC	1/2	3/4	49	0.14	1 ^{15/16}	0.31
1509-CB	3/4	1/2	55	0.20	2 ^{3/16}	0.44
1509-CD	3/4	1	64	0.32	2 ^{9/16}	0.71
1509-DC	1	3/4	68	0.44	2 ^{11/16}	0.97

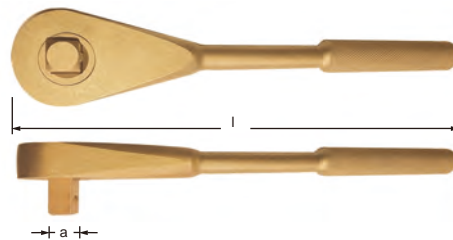

1501S Wrench, Ratchet

- Knarre
- Cliquet réversible
- Llave trinquete

No.	a inch	l mm	Δ kg	l inch	Wt. lbs.
1501S-AA	1/4	150	0.16	6	0.35
1501S-AB	3/8	200	0.38	8	0.85
1501S-B	1/2	260	0.60	10 ^{3/8}	1.32
1501S-C	3/4	390	2.28	15 ^{9/16}	5.03
1501S-D	1	600	3.40	24	7.56

When ordering, specify:

A=Aluminum Bronze

B=Copper Beryllium

Example:504S-24A

or

504S-24B



504S Wrench, Ratchet

- Knarreschlüssel
- Clé à cliquet
- Llave trinquete

No.	s mm	l mm	ΔΔ kg	No.	s inch	l inch	Wt. lbs.
504S-24	24	240	0.50	504SU-005	15/16	9 ⁹ / ₁₆	1.10
504S-27	27	270	0.72	504SU-010	1 ¹ / ₆	10 ³ / ₄	1.59
504S-30	30	300	0.89	504SU-015	1 ³ / ₆	12	1.96
504S-32	32	320	1.00	504SU-020	1 ¹ / ₄	12 ³ / ₄	2.20
504S-36	36	330	1.20	504SU-025	1 ⁷ / ₁₆	13 ³ / ₁₆	2.65
504S-41	41	330	1.37	504SU-030	1 ⁵ / ₈	13 ³ / ₁₆	3.02

*OTHER SIZES ON REQUEST

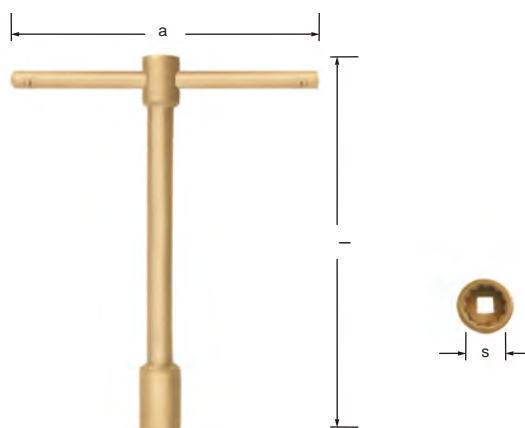

702 Wrench, Socket T-Type, 12-Point

- Dreikantsteckschlüssel
- Clé à douille
- Llave para cubo

No.	s mm	a mm	l mm	ΔΔ kg	No.	s inch	a inch	l inch	Wt. lbs.
702-14	14	200	170	0.58	702U-035	9/16	8	6 ³ / ₄	1.28
702-19	19	200	230	0.72	702U-055	3/4	8	9 ³ / ₁₆	1.59
702-22	22	250	260	0.97	702U-070	7/8	10	10 ³ / ₈	2.14
702-24	24	250	260	0.95	702U-075	15/16	10	10 ³ / ₈	2.09
702-30	30	260	260	1.04	702U-100	1 ³ / ₁₆	10 ³ / ₈	10 ³ / ₈	2.29
702-32	32	280	280	1.12	702U-105	1 ¹ / ₄	11 ³ / ₁₆	11 ³ / ₁₆	2.47
702-36	36	280	280	1.71	702U-120	1 ⁷ / ₁₆	11 ³ / ₁₆	11 ³ / ₁₆	3.77

When ordering, specify:
 A=Aluminum Bronze
 B=Copper Beryllium
 Example:1502-AA
 or
 1502-AB



1502 Bar, Sliding

- T-Gleitgriff
- Barre coulissante
- Barra deslizante

No.	a inch	l mm	ΔΔ kg	l inch	Wt. lbs.
1502-AA	1/4	150	0.07	6	0.15
1502-A	3/8	180	0.22	7 ^{3/16}	0.49
1502-B	1/2	250	0.37	10	0.82
1502-C	3/4	400	1.31	16	2.89
1502-D	1	400	1.62	16	3.57

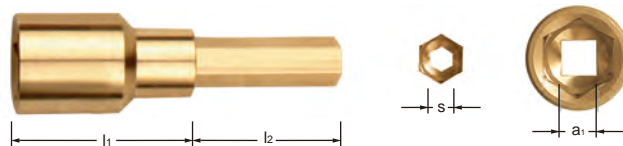

209HB Socket, 1/2" Drive, With Hexagon Head

- Steckschlüsseinsatz, 1/2" drive mit Sechskant
- Douille, 1/2" drive avec tête hexagonal
- Cubos, 1/2" drive con cabeza hexagonal

No.	a ₁ inch	s mm	l ₁ mm	l ₂ mm	ΔΔ kg
209HB-5	1/2	5	39	41	0.07
209HB-6	1/2	6	39	41	0.07
209HB-7	1/2	7	39	46	0.07
209HB-8	1/2	8	39	46	0.08
209HB-9	1/2	9	39	46	0.08
209HB-10	1/2	10	39	46	0.08
209HB-11	1/2	11	39	46	0.09
209HB-12	1/2	12	39	46	0.09
209HB-13	1/2	13	39	46	0.09
209HB-14	1/2	14	40	54	0.12
209HB-15	1/2	15	40	54	0.12
209HB-16	1/2	16	40	54	0.14
209HB-17	1/2	17	40	54	0.14

When ordering, specify:

A=Aluminum Bronze

B=Copper Beryllium

Example: 1720-7A

or

1720-7B

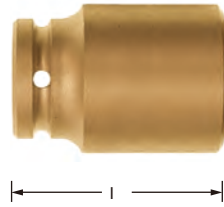

1720 Socket, Impact 3/8" Drive

- Schlagschraubereinsatz, 3/8" drive
- Douilles impact, 3/8" drive
- Cubos impact, 3/8" drive

No.	s mm	l mm	⚖ kg
1720-7	7	31	0.05
1720-8	8	31	0.05
1720-9	9	31	0.05
1720-10	10	31	0.05
1720-11	11	31	0.05
1720-12	12	31	0.05
1720-13	13	31	0.07
1720-14	14	31	0.07
1720-15	15	34	0.07
1720-16	16	34	0.08
1720-17	17	34	0.08
1720-18	18	34	0.09
1720-19	19	34	0.09

No.	s inch	l inch	Wt. lbs.
1720U-005	1/4	1 1/4	0.11
1720U-010	5/16	1 1/4	0.11
1720U-015	3/8	1 1/4	0.11
1720U-020	7/16	1 1/4	0.11
1720U-025	1/2	1 1/4	0.15
1720U-030	9/16	1 1/4	0.15
1720U-035	5/8	1 3/8	0.17
1720U-040	11/16	1 3/8	0.18
1720U-045	3/4	1 3/8	0.20

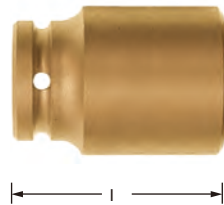

1730 Socket, Impact 1/2" Drive

- Schlagschraubereinsatz, 1/2" drive
- Douilles impact, 1/2" drive
- Cubos impact, 1/2" drive

No.	s mm	l mm	⚖ kg
1730-8	8	40	0.11
1730-9	9	40	0.11
1730-10	10	40	0.11
1730-11	11	40	0.11
1730-12	12	40	0.11
1730-13	13	40	0.11
1730-14	14	40	0.11
1730-15	15	40	0.17
1730-16	16	40	0.17
1730-17	17	40	0.17
1730-18	18	40	0.16
1730-19	19	40	0.17
1730-21	21	40	0.18
1730-22	22	40	0.20
1730-24	24	40	0.19
1730-27	27	40	0.21
1730-28	28	40	0.22
1730-29	29	40	0.22
1730-30	30	40	0.24

No.	s inch	l inch	Wt. lbs.
1730U-005	5/16	1 9/16	0.24
1730U-010	3/8	1 9/16	0.24
1730U-015	7/16	1 9/16	0.24
1730U-020	1/2	1 9/16	0.24
1730U-025	9/16	1 9/16	0.24
1730U-030	5/8	1 9/16	0.37
1730U-035	11/16	1 9/16	0.37
1730U-040	3/4	1 9/16	0.37
1730U-045	13/16	1 9/16	0.40
1730U-050	7/8	1 9/16	0.44
1730U-055	15/16	1 9/16	0.44
1730U-060	1	1 9/16	0.44
1730U-065	1 1/16	1 9/16	0.46
1730U-070	1 1/8	1 9/16	0.49
1730U-075	1 3/16	1 9/16	0.53

When ordering, specify:
A=Aluminum Bronze
B=Copper Beryllium
 Example: 1740-17A
 or
 1740-17B

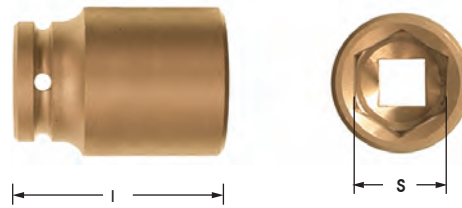

1740 Socket, Impact 3/4" Drive

- Schlagschraubereinsatz, 3/4" drive
- Douilles impact, 3/4" drive
- Cubos impact, 3/4" drive

No.	s mm	l mm	Δ kg
1740-17	17	49	0.47
1740-18	18	49	0.47
1740-19	19	49	0.47
1740-21	21	49	0.47
1740-22	22	49	0.51
1740-23	23	50	0.48
1740-24	24	50	0.47
1740-27	27	50	0.50
1740-28	28	54	0.57
1740-29	29	54	0.60
1740-30	30	56	0.66
1740-32	32	58	0.78
1740-34	34	63	0.96

No.	s inch	l inch	Wt. lbs.
1740U-005	3/4	1 ¹⁵ / ₁₆	1.04
1740U-010	13/1	1 ¹⁵ / ₁₆	1.04
1740U-015	7/8	1 ¹⁵ / ₁₆	1.04
1740U-020	15/16	1 ¹⁵ / ₁₆	1.12
1740U-030	1 ¹ / ₁₆	2	1.06
1740U-035	1 ¹ / ₈	2	1.04
1740U-040	1 ³ / ₁₆	2	1.10
1740U-045	1 ¹ / ₄	2 ¹ / ₈	1.26
1740U-050	1 ³ / ₈	2 ¹ / ₈	1.32
1740U-055	1 ⁷ / ₁₆	2 ¹ / ₄	1.46
1740U-070	1 ⁵ / ₈	2 ⁵ / ₁₆	1.72
1740U-085	1 ¹³ / ₁₆	2 ¹ / ₂	2.12

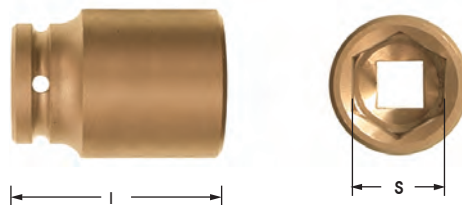

1750 Socket, Impact 1" Drive

- Schlagschraubereinsatz, 1" drive
- Douilles impact, 1" drive
- Cubos impact, 1" drive

No.	s mm	l mm	Δ kg
1750-22	22	60	0.80
1750-24	24	60	0.81
1750-27	27	60	0.81
1750-30	30	63	0.86
1750-32	32	63	0.86
1750-34	34	63	0.84
1750-36	36	67	0.96
1750-38	38	67	1.01
1750-41	41	70	1.13
1750-42	42	70	1.20
1750-43	43	70	1.26
1750-46	46	70	1.26
1750-50	50	70	1.36
1750-55	55	74	1.58
1750-60	60	78	1.82
1750-65	65	78	1.97
1750-70	70	78	2.10

No.	s inch	l inch	Wt. lbs.
1750U-005	7/8	2 ³ / ₈	1.76
1750U-010	15/16	2 ³ / ₈	7.79
1750U-015	1 ¹ / ₁₆	2 ³ / ₈	1.79
1750U-020	1 ³ / ₁₆	2 ¹ / ₂	1.90
1750U-025	1 ¹ / ₄	2 ¹ / ₂	1.90
1750U-030	1 ³ / ₈	2 ¹ / ₂	1.85
1750U-035	1 ⁷ / ₁₆	2 ¹¹ / ₁₆	2.12
1750U-040	1 ¹ / ₂	2 ¹¹ / ₁₆	2.23
1750U-045	1 ⁵ / ₈	2 ³ / ₄	2.49
1750U-050	1 ¹¹ / ₁₆	2 ³ / ₄	2.78
1750U-055	1 ¹³ / ₁₆	2 ³ / ₄	2.78
1750U-060	2	2 ³ / ₄	3.00
1750U-065	2 ³ / ₁₆	2 ¹⁵ / ₁₆	3.48
1750U-070	2 ³ / ₈	3 ¹ / ₈	4.01
1750U-075	2 ⁹ / ₁₆	3 ¹ / ₈	4.34
1750U-080	2 ³ / ₄	3 ¹ / ₈	4.63
1750U-085	2 ⁷ / ₈	3 ¹ / ₈	4.63

When ordering, specify:

A=Aluminum Bronze

B=Copper Beryllium

Example:1760-36A

or

1760-36B

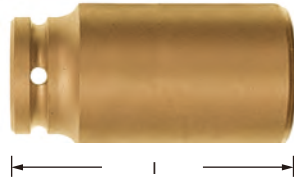

1760 Socket, Impact 1-1/2" Drive

- Schlagschraubereinsatz, 1-1/2"drive
- Douilles impact, 1-1/2"drive
- Cubos impact, 1-1/2"drive

No.	s mm	l mm	kg
1760-36	36	78	2.65
1760-41	41	80	2.72
1760-46	46	64	2.84
1760-50	50	87	2.90
1760-55	55	90	2.95
1760-60	60	95	3.04
1760-65	65	100	3.97
1760-70	70	105	4.33
1760-75	75	110	4.73
1760-80	80	115	5.55
1760-85	85	120	6.35
1760-90	90	125	7.42
1760-95	95	127	8.14
1760-100	100	130	9.10
1760-105	105	130	9.91

No.	s inch	l inch	Wt. lbs.
1760U-005	2 ^{7/16}	3 ^{1/8}	5.84
1760U-010	2 ^{5/8}	3 ^{3/16}	6.00
1760U-015	2 ^{13/16}	3 ^{3/8}	6.26
1760U-020	2	3 ^{7/16}	6.40
1760U-025	2 ^{3/16}	3 ^{9/16}	6.51
1760U-030	2 ^{3/8}	3 ^{3/4}	6.71
1760U-035	2 ^{9/16}	4	8.34
1760U-040	2 ^{3/4}	4 ^{3/16}	9.53
1760U-045	2 ^{15/16}	4 ^{5/16}	10.43
1760U-050	3 ^{1/8}	4 ^{17/32}	12.25
1760U-055	3 ^{3/8}	4 ^{3/4}	14.03
1760U-060	3 ^{1/2}	4 ^{15/16}	16.37
1760U-065	3 ^{3/4}	5	17.96
1760U-070	3 ^{15/16}	5 ^{1/8}	20.15
1760U-075	4 ^{1/8}	5 ^{1/8}	21.87

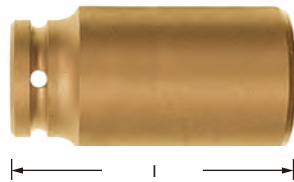

1820 Socket, Impact, Deep, 3/8" Drive

- Schlagschraubereinsatz, 3/8" drive,lang
- Douilles impact, 3/8" drive, longues
- Cubos impact, 3/8" drive, largo

No.	s mm	l mm	kg
1820-7	7	60	0.10
1820-8	8	60	0.10
1820-9	9	65	0.10
1820-10	10	65	0.10
1820-11	11	65	0.10
1820-12	12	65	0.09
1820-13	13	65	0.13
1820-14	14	65	0.13
1820-15	15	70	0.14
1820-16	16	70	0.15
1820-17	17	70	0.16
1820-18	18	70	0.17
1820-19	19	70	0.18

No.	s inch	l inch	Wt. lbs.
1820U-005	1/4	2	0.22
1820U-010	5/16	2	0.22
1820U-015	3/8	3	0.22
1820U-020	7/16	3	0.22
1820U-025	1/2	3	0.26
1820U-030	9/16	3	0.29
1820U-035	5/8	3	0.33
1820U-040	11/16	3	0.35
1820U-045	3/4	3	0.42

When ordering, specify:
A=Aluminum Bronze
B=Copper Beryllium
 Example:1830-6A
 or
 1830-6B

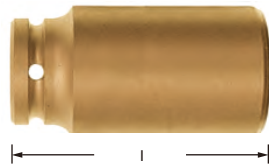

1830
Socket, Impact, Deep, 1/2" Drive

- Schlagschraubereinsatz, 1/2" drive, lang
- Douilles impact, 1/2" drive, longues
- Cubos impact, 1/2" drive, largo

No.	s mm	l mm	Δ kg
1830-6	6	85	0.22
1830-7	7	85	0.22
1830-8	8	85	0.22
1830-9	9	85	0.22
1830-10	10	85	0.22
1830-11	11	85	0.22
1830-12	12	85	0.22
1830-13	13	85	0.22
1830-14	14	85	0.22
1830-15	15	85	0.34
1830-16	16	85	0.34
1830-17	17	85	0.34
1830-18	18	85	0.32
1830-19	19	85	0.34
1830-20	20	85	0.34
1830-21	21	85	0.36
1830-22	22	85	0.40
1830-23	23	85	0.40
1830-24	24	85	0.38
1830-25	25	85	0.38
1830-26	26	85	0.42
1830-27	27	85	0.42
1830-28	28	85	0.44
1830-29	29	85	0.44
1830-30	30	85	0.48
1830-32	32	85	0.48

No.	s inch	l inch	Wt. lbs.
1830U-005	1/4	3	0.49
1830U-010	5/16	3	0.49
1830U-015	3/8	3	0.49
1830U-020	7/16	3	0.49
1830U-025	1/2	3	0.49
1830U-030	9/16	3	0.75
1830U-032	19/32	3	0.75
1830U-035	5/8	3	0.75
1830U-040	11/16	3	0.75
1830U-045	3/4	3	0.75
1830U-047	25/32	3	0.75
1830U-050	13/16	3	0.88
1830U-055	7/8	3	0.84
1830U-060	15/16	3	0.84
1830U-065	1	3	0.93
1830U-070	1 ^{1/16}	3	0.97
1830U-075	1 ^{1/8}	3	1.06
1830U-080	1 ^{3/16}	3	1.06
1830U-085	1 ^{1/4}	3	1.06
1830U-090	1 ^{5/16}	3	1.06
1830U-095	1 ^{3/8}	3	1.06

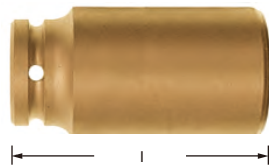

1840
Socket, Impact, Deep, 3/4" Drive

- Schlagschraubereinsatz, 3/4" drive, lang
- Douilles impact, 3/4" drive, longues
- Cubos impact, 3/4" drive, largo

No.	s mm	l mm	Δ kg
1840-19	19	90	0.94
1840-22	22	90	1.02
1840-24	24	90	0.94
1840-27	27	90	1.10
1840-30	30	90	1.32
1840-32	32	90	1.56
1840-34	34	90	1.92
1840-36	36	100	0.40
1840-41	41	100	0.45
1840-46	46	100	0.60
1840-50	50	100	0.70
1840-55	55	100	0.85
1840-60	60	100	1.30

No.	s inch	l inch	Wt. lbs.
1840U-005	3/4	4	2.06
1840U-010	13/16	4	2.06
1840U-015	7/8	4	2.25
1840U-020	15/16	4	2.25
1840U-025	1	4	2.06
1840U-030	1 ^{1/16}	4	2.43
1840U-035	1 ^{1/8}	4	2.43
1840U-040	1 ^{3/16}	4	3.44
1840U-045	1 ^{1/4}	4	2.91
1840U-050	1 ^{3/8}	4	4.24
1840U-055	1 ^{7/16}	4	4.24
1840U-060	1 ^{1/2}	4	0.88
1840U-065	1 ^{9/16}	4	0.99
1840U-070	1 ^{5/8}	4	0.99
1840U-075	1 ^{11/16}	4	0.99
1840U-080	1 ^{3/4}	4	1.32
1840U-085	1 ^{13/16}	4	1.32
1840U-090	1 ^{7/8}	4	1.32
1840U-095	1 ^{15/16}	4	1.55
1840U-100	2	4	1.55

When ordering, specify:

A=Aluminum Bronze

B=Copper Beryllium

Example: 1850-22A

or

1850-22B

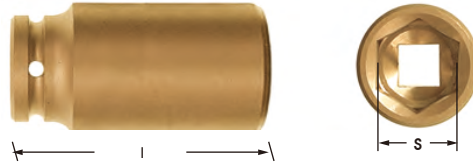

1850 Socket, Impact, Deep, 1" Drive

- Schlagschraubereinsatz, 1" drive, lang
- Douilles impact, 1" drive, longues
- Cubos impact, 1" drive, largo

No.	s mm	l mm	△ kg
1850-22	22	150	1.60
1850-24	24	150	1.62
1850-27	27	150	1.62
1850-30	30	150	1.72
1850-32	32	150	1.72
1850-34	34	150	1.68
1850-36	36	150	1.92
1850-38	38	150	2.02
1850-41	41	150	2.26
1850-42	42	150	2.40
1850-43	43	150	2.52
1850-46	46	150	2.52
1850-50	50	150	2.72
1850-55	55	150	3.16
1850-60	60	150	3.64
1850-65	65	150	3.94
1850-70	70	150	4.20

No.	s inch	l inch	Wt. lbs.
1850U-005	7/8	6	3.53
1850U-010	15/16	6	3.53
1850U-015	1 ^{1/16}	6	3.52
1850U-020	1 ^{3/16}	6	3.80
1850U-025	1 ^{1/4}	6	3.80
1850U-030	1 ^{3/8}	6	3.71
1850U-035	1 ^{7/16}	6	4.24
1850U-040	1 ^{1/2}	6	4.46
1850U-045	1 ^{5/8}	6	5.00
1850U-050	1 ^{11/16}	6	5.56
1850U-055	1 ^{13/16}	6	5.56
1850U-060	2	6	6.00
1850U-065	2 ^{3/16}	6	6.98
1850U-070	2 ^{3/8}	6	8.04
1850U-075	2 ^{9/16}	6	8.70
1850U-080	2 ^{3/4}	6	9.27

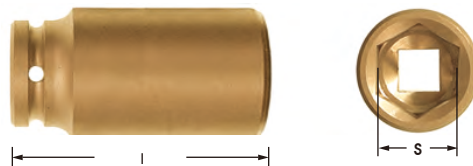

1860 Socket, Impact, Deep, 1-1/2" Drive

- Schlagschraubereinsatz, 1-1/2" drive, lang
- Douilles impact, 1-1/2" drive, longues
- Cubos impact, 1-1/2" drive, largo

No.	s mm	l mm	△ kg
1860-36	36	85	5.30
1860-41	41	85	5.44
1860-46	46	85	5.68
1860-50	50	85	5.80
1860-55	55	85	5.90
1860-60	60	85	6.08
1860-65	65	85	7.58
1860-70	70	85	8.66

No.	s inch	l inch	Wt. lbs.
1860U-005	1 ^{7/16}	3	11.70
1860U-010	1 ^{5/8}	3	12.00
1860U-015	1 ^{15/16}	3	12.80
1860U-020	2	3	12.80
1860U-025	2 ^{3/16}	3	13.02
1860U-030	2 ^{3/8}	3	13.42
1860U-035	2 ^{9/16}	3	16.74
1860U-040	2 ^{3/4}	3	19.12

When ordering, specify:
A=Aluminum Bronze
B=Copper Beryllium
 Example: 1514B-8A
 or
 1514B-8B



1401 Wrench, Torque

Copper Beryllium (CuBe) only

- Drehmomentschraubenschlüssel
- Clé dynamométrique
- Llave dinamométrica

No.	Drive inch	Torque N.m	l mm	$\Delta\Delta$ kg	l inch	Wt. lbs.
1401A-545B	3/8	5-45	415	1.56	16 ^{5/16}	3.44
1401B-30150B	1/2	30-150	463	2.21	8 ^{1/4}	4.87

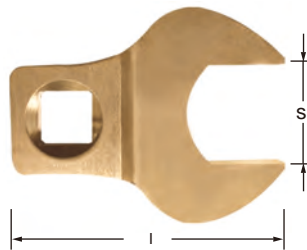

1514B Wrench, Crowfoot 1/2" Drive

- Maulschlüssel für Drehmomentschlüssel
- Clé à fourche pour clé dynamométrique
- Llave de boca por llave de torsion

No.	s mm	l mm	$\Delta\Delta$ kg	No.	s inch	l inch	Wt. lbs.
1514B-8	8	40	0.02	1514BU-005	1/4	1 ^{9/16}	0.04
1514B-10	10	43	0.02	1514BU-010	5/16	1 ^{11/16}	0.04
1514B-11	11	43	0.02	1514BU-015	3/8	1 ^{11/16}	0.04
1514B-12	12	47	0.04	1514BU-020	7/16	1 ^{7/8}	0.08
1514B-13	13	47	0.04	1514BU-025	1/2	1 ^{7/8}	0.08
1514B-14	14	50	0.08	1514BU-030	9/16	2	0.17
1514B-15	15	50	0.08	1514BU-035	5/8	2	0.17
1514B-16	16	56	0.10	1514BU-040	11/16	2 ^{6/13}	0.22
1514B-17	17	56	0.10	1514BU-045	3/4	2 ^{6/13}	0.22
1514B-18	18	56	0.10	1514BU-047	25/32	2 ^{6/13}	0.22
1514B-19	19	60	0.10	1514BU-050	13/16	2 ^{3/8}	0.22
1514B-21	21	60	0.10	1514BU-055	7/8	2 ^{3/8}	0.22
1514B-22	22	64	0.12	1514BU-060	15/16	2 ^{1/2}	0.26
1514B-24	24	67	0.15	1514BU-065	1	2 ^{5/8}	0.33
1514B-27	27	71	0.20	1514BU-070	1 ^{1/16}	2 ^{13/16}	0.44
1514B-30	30	84	0.33	1514BU-075	1 ^{1/8}	2 ^{13/16}	0.73
1514B-32	32	84	0.33	1514BU-080	1 ^{3/16}	3 ^{5/16}	0.73
				1514BU-085	1 ^{1/4}	3 ^{5/16}	0.73
				1514BU-090	1 ^{5/16}	3 ^{5/16}	0.73
				1514BU-095	1 ^{3/8}	3 ^{5/16}	0.73
				1514BU-100	1 ^{7/16}	3 ^{5/16}	0.73
				1514BU-110	1 ^{1/2}	3 ^{5/16}	0.73

When ordering, specify:

A=Aluminum Bronze

B=Copper Beryllium

Example:505U-005A

or

505U-005B

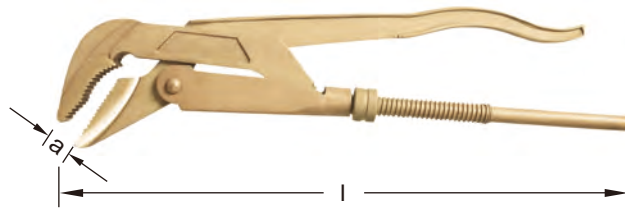

505U
Pliers, Swedish (DIN 5234)

- Eckrohrzange
- Clé serre-tube, type suédois
- Pinza sueca

No.	a max mm	l mm	ΔΔ kg	a max inch	l inch	Wt. lbs.
505U-005	40	300	0.69	1 ⁹ / ₁₆	12	1.52
505U-010	55	420	1.49	2 ³ / ₁₆	16 ³ / ₄	3.28
505U-015	67	530	3.24	2 ¹¹ / ₁₆	21 ³ / ₁₆	7.14

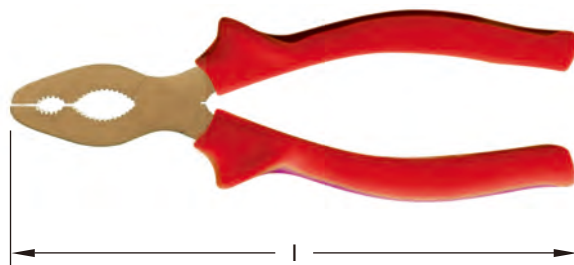

602
Pliers, Pipe

- Gasbrennerzange
- Pince à gaz
- Alicata para tubo gas

No.	l mm	ΔΔ kg	l inch	Wt. lbs.
602-8	200	0.45	8	0.99

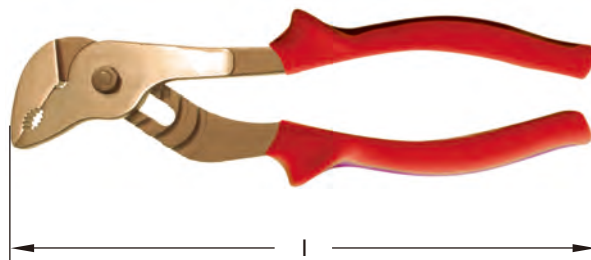

604
Pliers, Groove Joint

- Wasserpumpenzange
- Pince multiprise
- Pinza junta estrilla

No.	a max mm	l mm	ΔΔ kg	a max inch	l inch	Wt. lbs.
604-10	28	250	0.34	1 ¹ / ₈	10	0.75
604-12	48	300	0.55	1 ⁷ / ₈	12	1.21
604-14	55	350	1.18	2 ³ / ₁₆	14	2.60
604-16	80	430	1.66	3 ³ / ₁₆	17 ³ / ₁₆	3.66

When ordering, specify:
 A=Aluminum Bronze
 B=Copper Beryllium
 Example:605-8A
 or
 605-8B

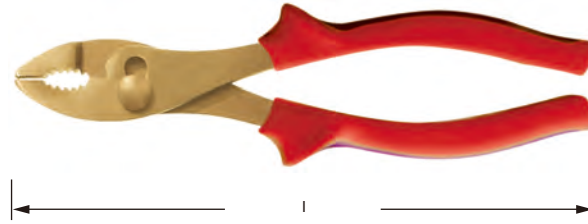

605
 Pliers, Adjustable Combination

- Verstellbare Kombinationszange
- Pince combinée
- Alicates ajustable

No.	mm	Δ kg	inch	Wt. lbs.
605-8	200	0.21	8	0.46

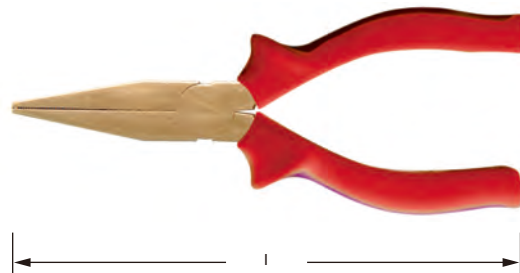

606
 Pliers, Flat Nose
 (DIN ISO 5745)

- Flachzange
- Pince plate
- Alicates de punta aplanada

No.	mm	Δ kg	inch	Wt. lbs.
606-6	150	0.17	6	0.37

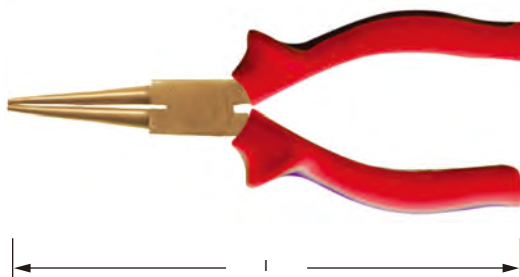

607
 Pliers, Round Nose
 (DIN ISO 5745)

- Rundzange
- Pince becs ronds
- Alicates, bocas redondas

No.	mm	Δ kg	inch	Wt. lbs.
607-6	150	0.14	6	0.31

When ordering, specify:

A=Aluminum Bronze

B=Copper Beryllium

Example: 611-6A

or

611-6B

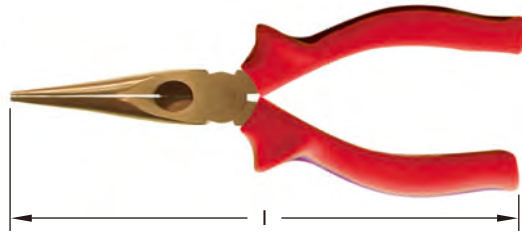

611
Pliers, Long- Nose W/ Side Cutter
(DIN ISO 5745)

- Telefonzange
- Pince demi-ronde, long bec
- Alicates de punta larga con cortador

No.	l mm	Δ kg	l inch	Wt. lbs.
611-6	150	0.16	6	0.35
611-7	180	0.21	7 ^{3/16}	0.46

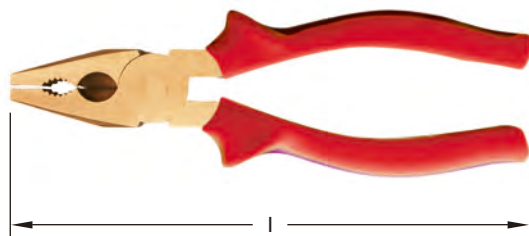

612
Pliers, Lineman's, Side Cutting

- Kombinationszange
- Pince universelle
- Alicates universal

No.	l mm	Δ kg	l inch	Wt. lbs.
612-6	160	0.25	6 ^{3/8}	0.55
612-7	180	0.26	7 ^{3/16}	0.57
612-8	200	0.46	8	1.01

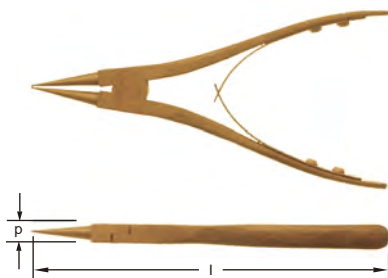

614
Pliers, Snap Ring, Outside
Copper Beryllium (CuBe) only

- Sicherungszange (aussen)
- Pinza abre anillos exteriores
- Pince pour circlips extérieurs

No.	Ring dia mm	p mm	l mm	Δ kg
614-310B	3-10	7	140	0.09
614-1025B	10-25	7	140	0.09
614-1960B	19-60	9	180	0.13
614-40100B	40-100	11	225	0.25
614-85165B	85-165	14	305	0.62
614-125300B	125-300	17	500	1.23

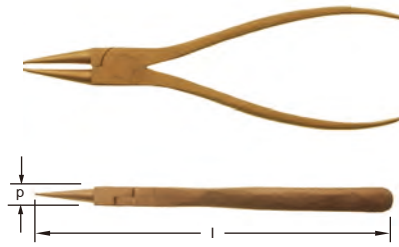

615

Pliers, Snap Ring, Inside

Copper Beryllium (CuBe) only

- Sicherungszange (Innen)
- Pinza abre anillos interiores
- Pince pour circlips intérieurs

No.	Ring dia mm	p mm	l mm	Δ kg
615-825B	8-25	7	140	0.07
615-1960B	19-60	9	180	0.14
615-40100B	40-100	11	220	0.25
615-85165B	85-165	15	270	0.47
615-125300B	125-300	17	500	1.12



209

Allen/ Hex Key

Screwdriver Handle
Copper Beryllium (CuBe) only

- Sätze Sechskant-Winkelschraubendreher
- Set de clés mâles pour vis creuses
- Juego de llaves allen hexagonales

No.	s mm
209-1.5B	1.5
209-2B	2
209-3B	3
209-4B	4
209-5B	5
209-6B	6
209-7B	7
209-8B	8
209-9B	9
209-10B	10



209L

Allen/ Hex Key

Ball Point, Screwdriver Handle
Copper Beryllium (CuBe) only

- Sätze Sechskant-Winkelschraubendreher
- Set de clés mâles pour vis creuses
- Juego de llaves allen hexagonales

No.	s mm
209L-1.5B	1.5
209L-2B	2
209L-3B	3
209L-4B	4
209L-5B	5
209L-6B	6
209L-7B	7
209L-8B	8
209L-9B	9
209L-10B	10

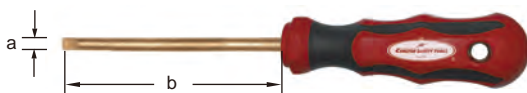

801

Screwdriver, Standard

Copper Beryllium (CuBe) only

- Schlitz-Schraubendreher
- Tournevis, lame cylindrique
- Destronillador, hoja cilíndrica

No.	a mm	b mm	Δ kg
801-3-50B	3	50	0.01
801-4-100B	4	100	0.02
801-5-125B	5	125	0.03
801-6-100B	6	100	0.04
801-6-150B	6	150	0.05
801-8-150B	8	150	0.09
801-8-200B	8	200	0.11
801-10-200B	10	200	0.17
801-10-300B	10	300	0.25
801-12-250B	12	250	0.29
801-14-250B	14	250	0.39



803 +

Screwdriver, Phillips

Copper Beryllium (CuBe) only

- Kreuzschlitz-Schraubendreher
- Tournevis Phillips
- Destronillador estrella

No.	PH No.	b mm	Δ kg	b inch	Wt. lbs.
803-0B	0	60	0.015	2 ³ / ₈	0.02
803-1B	1	80	0.022	3 ³ / ₁₆	0.05
803-2B	2	100	0.036	4	0.08
803-3B	3	150	0.085	6	0.19
803-4B	4	200	0.170	8	0.37

801S Screwdriver

Striking
Copper Beryllium (CuBe) only



- Schraubendreher
- Tournevis
- Destornillador

No.	a mm	b mm	Δ kg	a inch	b inch	Wt. lbs.
801S-8150B	8	150	0.23	5/16	6	0.51

804 Screwdriver, Torx Type

Copper Beryllium (CuBe) only

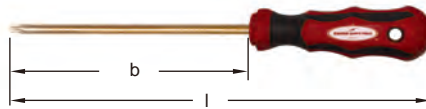

- Torx Schraubendreher
- Torx Tournevis
- Torx destornillador

No.	TX NO.	b mm	l mm	Δ kg	No.	TX NO.	b mm	l mm	Δ kg
804T-05B	5	60	150	0.04	804T-25B	25	100	200	0.08
804T-06B	6	60	150	0.04	804T-27B	27	115	225	0.12
804T-07B	7	60	150	0.04	804T-30B	30	115	225	0.12
804T-08B	8	60	150	0.04	804T-40B	40	130	250	0.19
804T-09B	9	60	150	0.04	804T-45B	45	130	250	0.20
804T-10B	10	80	170	0.05	804T-50B	50	150	270	0.25
804T-15B	15	80	180	0.07	804T-55B	55	150	270	0.26
804T-20B	20	100	200	0.08	804T-60B	60	150	270	0.33



209SKit-7 Allen/ Hex Key

Screwdriver Handle
Copper Beryllium (CuBe) only

- Sätze Sechskant-Winkelschraubendreher
- Set de clés mâles pour vis creuses
- Juego de llaves allen hexagonales

No.	S mm
209SKit-7B	2, 3, 4, 5, 6, 8, 10

*PLASTIC CASE INCLUDED



209LSKit-7 Allen/ Hex Key

Ball Point, Screwdriver Handle
Copper Beryllium (CuBe) only

- Sätze Sechskant-Winkelschraubendreher
- Set de clés mâles pour vis creuses
- Juego de llaves allen hexagonales

No.	S mm
209LSKit-7B	2, 3, 4, 5, 6, 8, 10

*PLASTIC CASE INCLUDED





804Kit-5 
Screwdriver, Torx Kit
 Copper Beryllium (CuBe) only

- Sätze Torx Schraubendreher
- Jeu de tournevis Torx
- Juego de destornilladores torx

No.	H No.
804Kit-5B	T10, T15, T20, T25, T30

*PLASTIC CASE INCLUDED



801Kit-6  
Screwdriver Kit
 Copper Beryllium (CuBe) only

- Sätze Schraubendreher
- Jeu de tournevis
- Juego de destornilladores

No.	PH No.	Dimensions	Quantity
801-6100B		6x100	1
801-8150B		8x150	1
801-10200B		10x200	1
803-1B	1	No.1	1
803-2B	2	No.2	1
803-3B	3	No.3	1

*PLASTIC CASE INCLUDED



802 
Screwdriver, Offset
 Copper Beryllium (CuBe) only

- Winkelschraubendreher
- Tournevis coudé
- Destornillador acodado

No.	a mm	b mm	kg	No.	s inch	l inch	Wt. lbs.
802-3	3	100	0.01	802U-010B	1/8	4	0.02
802-4	4	110	0.02	802U-020B	1/4	5 ⁹ / ₁₆	0.11
802-6	6	140	0.05	802U-030B	3/8	7 ³ / ₁₆	0.42
802-8	8	160	0.10	802U-040B	9/16	10	1.10
802-10	10	180	0.20				
802-12	12	200	0.30				
802-14	14	250	0.50				

STRIKING

Hammers Punches Chisels Wedges



When ordering, specify:
 A=Aluminum Bronze
 B=Copper Beryllium
 Example:101U-0025A
 or
 101U-0025B



101U
 Hammer, Ball Peen

- Schlosserhammer, amerikanischer Form
- Marteau de mécanicien - type américain
- Martillo de ingeniero

No.	H lbs	H g	l mm	ΔΔ g
101U-0025	0.25	115	250	170
101U-0075	0.75	340	350	585
101U-0100	1.00	455	350	700
101U-0150	1.50	680	360	895
101U-0200	2.00	905	360	1170
101U-0225	2.25	1020	360	1305
101U-0275	2.75	1250	360	1410

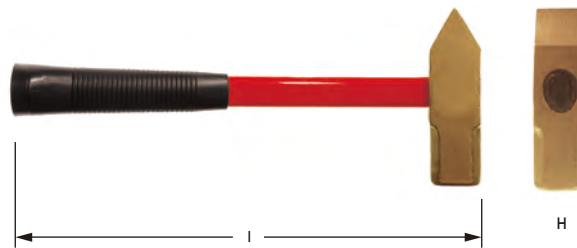

102U
 Hammer, Cross Peen
 Engineers'

- Handhammer, amerikanische Form
- Massette anglaise
- Martillo de ingeniero de golpe cruzado

No.	H lbs	H g	l mm	ΔΔ g
102U-0150	1.50	680	355	970
102U-0250	2.50	1135	380	1510
102U-0350	3.50	1590	380	1950



103U
 Hammer, Double Face
 Machinists'

- Maschinistenhammer
- Marteau d'ajusteur
- Martillo de maquinista

No.	H lbs	H g	l mm	ΔΔ g
103U-0025	0.25	115	250	170
103U-0150	1.50	680	360	895
103U-0175	1.75	800	360	920
103U-0200	2.00	910	360	1080

When ordering, specify:

A=Aluminum Bronze

B=Copper Beryllium

Example:104U-0300A

or

104U-0300B

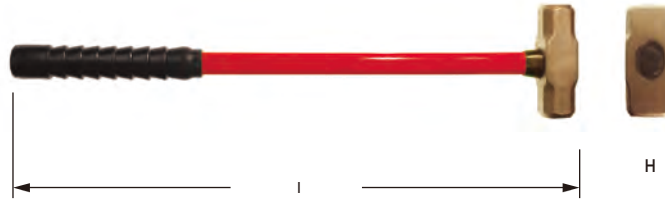

104U
Hammer, Sledge

- Faustel,amerikanischer Form
- Masse à pans
- Acotillo

No.	H lbs	H g	l mm	△ g
104U-0200	2.00	907	245	1160
104U-0300	3.00	1360	380	1570
104U-0400	4.00	1814	380	2154
104U-0500	5.00	2270	840	3220
104U-0750	7.50	3400	840	4300
104U-1000	10.00	4540	840	5030
104U-1200	15.00	5442	840	5442
104U-1500	12.00	6800	840	7300
104U-1800	18.00	8170	840	8740
104U-2200	22.00	9977	840	10977

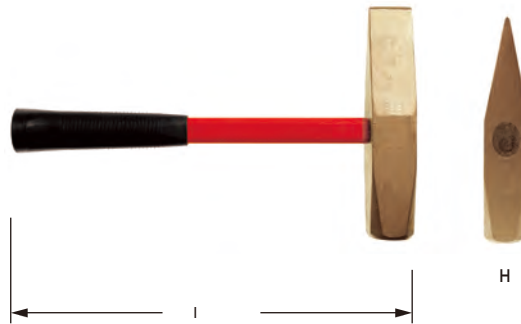

105U
Hammer, Cutoff

- Schrotmeissel
- Marteau de burinage
- Martillo de corte

No.	H lbs	H g	l mm	△ g
105U-0300	3.00	1360	380	1495
105U-0500	5.00	2270	380	2400

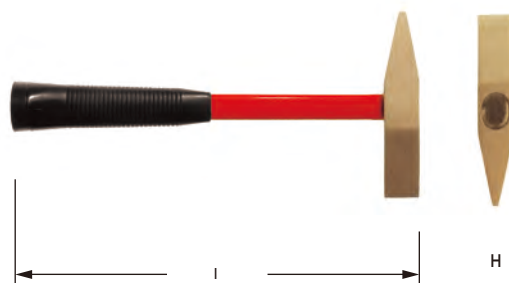

106U
Hammer, Scaling

- Entrostungshammer
- Marteau à piquer
- Martillo burilador

No.	H lbs	H g	l mm	△ g
106U-0100	1.00	455	355	680
106U-0150	1.50	680	355	930
106U-0300	3.00	1360	380	1550

When ordering, specify:
 A=Aluminum Bronze
 B=Copper Beryllium
 Example: 106U-0100A
 or
 106U-0100B

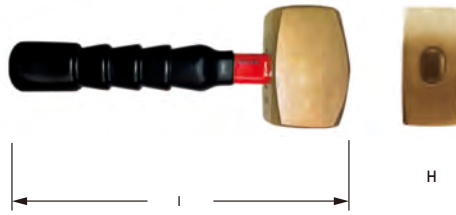

108U
 Hammer, Club

Faustel, Club hammer
 Massette carrée
 Martillo de doble cabeza

No.	H lbs	H g	I mm	Δ g
108U-0200	2.00	910	255	1185
108U-0400	4.00	1820	255	2020
108U-0700	7.00	3150	840	4150



109U
 Hammer, Double Face Engineer's

- Handhammer
- Massette carrée
- Martillo de Doble Cabeza

No.	H lbs	H g	I mm	Δ g
109U-0175	1.75	800	335	1045
109U-0225	2.25	1020	335	1280
109U-0275	2.75	1250	380	1530
109U-0300	3.00	1360	350	1680

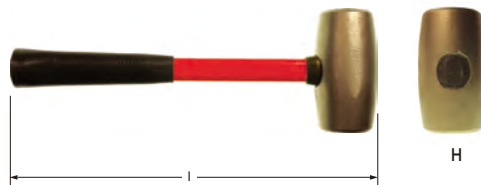

110U
 Mallet

- Schlägel
- Massette, forme baril
- Mazo

No.	H lbs	H g	I mm	Δ g
110U-0200	2.00	900	360	1110
110U-0400	4.00	1820	380	1990
110U-0600	6.00	2730	380	2870



112U
 Hammer, Bricklayers'

- Maurerhammer
- Marteau de maçon
- Martillo de albañil

No.	H lbs	H g	I mm	Δ g
112U-0150	1.50	680	360	1030

When ordering, specify:

A=Aluminum Bronze

B=Copper Beryllium

Example: 113S-230A

or

113S-230B



113S
Crate Opener

- Verschlagöffner
- Ouvre-caisses
- Abre cajas

No.	a mm	l mm	Δ kg	a inch	l inch	Wt. lbs.
113S-230	70	230	0.51	2 ³ / ₄	9 ³ / ₁₆	1.12



121U
Hammer, Plastic

- Kunststoffhammer
- Marteau embouts plastique
- Martillo de plástico

No.	H lbs	H g	l mm	l inch
121U-0100	1.00	450	355	14.0
121U-0220	2.20	1000	355	12.5

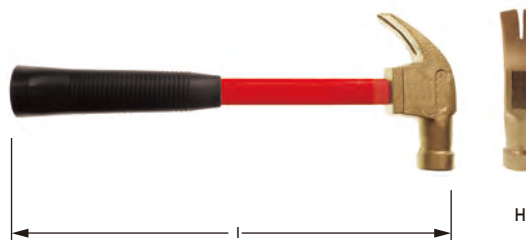

122U
Hammer, Claw

- Klauenhammer
- Marteau de charpentier
- Martillo con garra

No.	H lbs	H g	l mm	Δ g
122U-0075	0.75	340	360	645
122U-0100	1.00	455	360	760
122U-0125	1.25	570	360	955

When ordering, specify:
 A=Aluminum Bronze
 B=Copper Beryllium
 Example:1041-0100A
 or
 1041-0100B



1041
 Hammer, Cross Peen
 German Type

- Handhammer, amerikanische Form
- Massette anglaise
- Martillo de ingeniero de golpe cruzado

No.	H g	l mm	△ g
1041-0100	100	250	150
1041-0150	150	250	220
1041-0200	200	250	300
1041-0300	300	355	400
1041-0400	400	355	520
1041-0500	500	355	650
1041-0600	600	355	750
1041-0700	700	355	900
1041-0800	800	355	1000
1041-1000	1000	355	1250
1041-1250	1250	380	1550
1041-1500	1500	380	1850
1041-2000	2000	380	2400

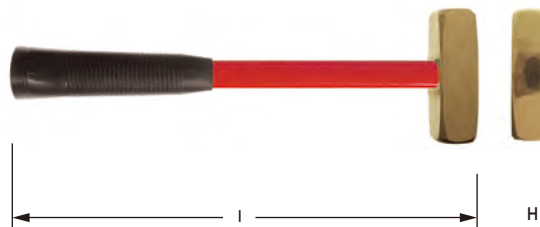

6475
 Hammer, Sledge
 German Type

- Faustel
- Masse à pans
- Acotillo

No.	H g	l mm	△ g
6475-0100	1000	355	1200
6475-0125	1250	380	1450
6475-0150	1500	380	1750
6475-0200	2000	380	2250
6475-0250	2500	840	2800
6475-0300	3000	840	3350
6475-0400	4000	840	4400
6475-0500	5000	840	5500
6475-0600	6000	840	6600
6475-0800	8000	840	8700
6475-1000	10000	840	10800

When ordering, specify:

A=Aluminum Bronze

B=Copper Beryllium

Example: 1101-61350A

or

1101-61350B

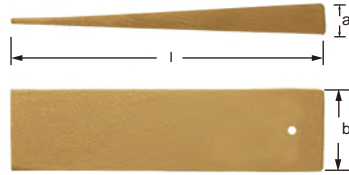

1101U Wedge, Flange

- Flanschkeil
- Coin, casse joint
- Cuña de pestaña

No.	New size axbxl INCH (mm)	Wt. g.	Wt. lbs.
1101U-1	1/4 X 1/2 X 3 (6 x 13 x 80mm)	50	0.11
1101U-2	1/2 X 3/4 X 4 (13 x 19 x 105mm)	100	0.22
1101U-3	1/2 X 1 X 6 (13 x 25 x 150mm)	200	0.44
1101U-4	3/4 X 1 1/2 X 6 (19 x 38 x 150mm)	400	0.88
1101U-5	1/2 X 1 1/4 X 7 (13 x 32 x 180mm)	300	0.66
1101U-6	3/4 X 2 X 7 (19 x 50 x 180mm)	730	1.61
1101U-7	1 5/8 X 1 1/2 X 8 (41 x 38 x 200mm)	1300	2.86
1101U-8	1 X 1 1/2 X 8 (25 x 38 x 200mm)	800	1.76
1101U-9	3/4 X 2 X 8 (19 x 50 x 200mm)	805	1.77
1101U-10	1 1/4 X 2 X 8 1/2 (32 x 50 x 215mm)	1400	3.08
1101U-11	3/8 X 2 X 7 (10 x 50 x 180mm)	400	0.88
1101U-12	3/8 X 2 X 3 1/2 (10 x 50 x 90mm)	200	0.44
1101U-13	2 X 2 X 8 (50 x 50 x 200mm)	2085	4.59

1101B Wedge, Banana

Copper Beryllium (CuBe) only



- Meissel für Maschinen
- Burin pour les machines
- Cincel para la máquina

No.	a inch	l inch	Wt. lbs.
1101C-20300B	3/4	12	1.6



301P Punch, Pin

- Splintreiber
- Chasse-goupilles
- Botador

No.	a mm	b mm	l mm	Δ kg	No.	a inch	b inch	l inch	Wt. lbs.
301P-1.4	1.4	10	110	0.05	301PU-005	7/128	3/8	4 3/8	0.10
301P-1.8	1.8	10	110	0.05	301PU-010	9/128	3/8	4 3/8	0.10
301P-2	2.0	10	150	0.07	301PU-015	1/16	3/8	6	0.16
301P-2.4	2.4	10	110	0.05	301PU-020	3/32	3/8	4 3/8	0.10
301P-2.8	2.8	10	110	0.05	301PU-025	7/64	3/8	4 3/8	0.11
301P-3	3.0	10	150	0.07	301PU-030	1/8	3/8	6	0.15
301P-4	4.0	10	150	0.07	301PU-035	3/16	3/8	6	0.15
301P-5	5.0	10	150	0.07	301PU-040	1/4	3/8	6	0.16
301P-6	6.0	10	150	0.07	301PU-045	5/16	7/16	6	0.25
301P-7	7.0	12	150	0.11	301PU-050	3/8	9/16	6	0.35
301P-8	8.0	12	150	0.11					
301P-10	10.0	14	150	0.16					

When ordering, specify:
A=Aluminum Bronze
B=Copper Beryllium
 Example:301C-2A
 or
 301C-2B

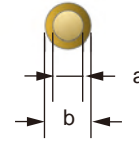

301C Drift Pin, Straight Type

- Durchtreiber, konisch
- Chasse-clou
- Perno de dirección, tipo recto

No.	a mm	b mm	l mm	ΔΔ kg	No.	a inch	b inch	l inch	Wt. lbs.
301C-2	2	10	150	0.08	301CU-005	1/16	3/8	6	0.17
301C-3	3	10	150	0.08	301CU-010	1/8	3/8	6	0.18
301C-4	4	10	150	0.08	301CU-015	3/16	3/8	6	0.19
301C-5	5	10	150	0.08	301CU-020	1/4	3/8	6	0.19
301C-6	6	10	150	0.09	301CU-025	5/16	7/16	6	0.28
301C-7	7	12	150	0.13	301CU-030	3/8	9/16	6	0.38
301C-8	8	12	150	0.13	301CU-035	7/16	5/8	6	0.51
301C-9	9	14	150	0.17	301CU-040	1/2	11/16	6	0.65
301C-10	10	14	150	0.18	301CU-045	9/16	11/16	6	0.66
301C-11	11	16	150	0.23	301CU-050	5/8	3/4	8	1.10
301C-12	12	16	150	0.23	301CU-055	11/16	7/8	8	1.32
301C-13	13	18	150	0.29	301CU-060	3/4	15/16	10	1.97
301C-14	14	18	150	0.30	301CU-065	13/16	1	10	2.32
301C-15	15	20	200	0.49	301CU-070	7/8	1	10	2.35
301C-16	16	20	200	0.50	301CU-075	15/16	1 ^{1/16}	10	
301C-17	17	22	200	0.60	301CU-085	1 ^{1/16}	1 ^{1/4}	11	
301C-18	18	22	200	0.61	301CU-095	1 ^{3/16}	1 ^{5/16}	11	
301C-19	19	24	250	0.89					
301C-20	20	24	250	0.91					
301C-21	21	26	250	1.05					
301C-22	22	26	250	1.07					

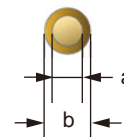
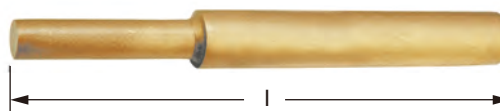

301 Drift, Cylindrical

- Durchtreiber
- Chasse clou cylindrique
- Perno de direccion

No.	a mm	b mm	l mm	ΔΔ kg	No.	a inch	b inch	l inch	Wt. lbs.
301-4	4	10	110	0.05	301U-005	1/8	3/8	4 ^{3/8}	0.11
301-6	6	12	115	0.08	301U-010	1/4	7/16	4 ^{9/16}	0.18
301-7	7	14	120	0.12	301U-015	5/16	9/16	4 ^{3/4}	0.26
301-8	8	14	120	0.12	301U-020	3/8	5/8	5 ^{3/4}	0.43
301-10	10	16	145	0.20	301U-025	7/16	11/16	6 ^{3/8}	0.62
301-12	12	18	160	0.28	301U-030	9/16	3/4	7 ^{3/16}	0.87
301-14	14	20	180	0.40	301U-035	5/8	15/16	8	1.37
301-16	16	24	200	0.62	301U-040	11/16	1 ^{3/16}	9	2.32
301-18	18	30	225	1.05	301U-045	3/4	1 ^{1/4}	9	2.67
301-20	20	32	225	1.21	301U-050	1 ^{1/4}	1 ^{9/16}	10	5.15
301-32	32	40	250	2.34					

When ordering, specify:

A=Aluminum Bronze

B=Copper Beryllium

Example:303-100A

or

303-100B

303 Punch, Center



- Körner
- Pointeau
- Punzón de marcar

No.	a mm	l mm	Δ kg	No.	a inch	l inch	Wt. lbs.
303-100	10	100	0.05	303U-005	3/8	4	0.11
303-150	12	150	0.11	303U-010	7/16	6	0.25
303-240	24	240	0.72	303U-015	15/16	9 ^{9/16}	1.58
303-260	26	260	0.89	303U-020	1	10 ^{3/8}	1.95
303-280	28	280	1.11	303U-025	1 ^{1/8}	11 ^{3/16}	2.45
303-300	30	300	1.34	303U-030	1 ^{3/16}	12	2.95
303-320	32	320	1.63	303U-035	1 ^{1/4}	12 ^{3/4}	3.60

304 Chisel, Hand



- Flachmeissel
- Burin
- Cincel de mano

No.	a mm	l mm	Δ kg	a inch	l inch	Wt. lbs.
304-100	14	100	0.09	9/16	4	0.20
304-125	14	125	0.12	9/16	5	0.26
304-150	17	150	0.20	11/16	6	0.45
304-175	20	175	0.31	3/4	7	0.68
304-200	22	200	0.41	7/8	8	0.90
304-250	24	250	0.58	15/16	10	1.28
304-300	24	300	0.69	15/16	12	1.52
304-400	27	400	1.23	1 ^{1/16}	16	2.71

304A Chisel, 6-Point

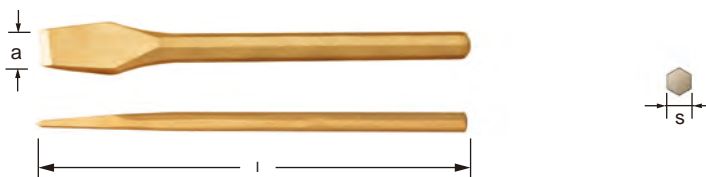

- Meissel, 6-Kant
- Burin, 6-points
- Cincel, 6-puntos

No.	a mm	s mm	l mm	Δ kg	a inch	s inch	l inch	Wt. lbs.
304A-300	16	14	300	0.43	5/8	9/16	12	0.95

304S Chisel, 8-Point



- Meissel, 8-Kant
- Burin, 8-points
- Cincel, 8-puntos

No.	a mm	s mm	l mm	Δ kg	a inch	s inch	l inch	Wt. lbs.
304S-300	26	18	300	0.67	1	11/16	12	1.48

When ordering, specify:
 A=Aluminum Bronze
 B=Copper Beryllium
 Example:305-200A
 or
 305-200B

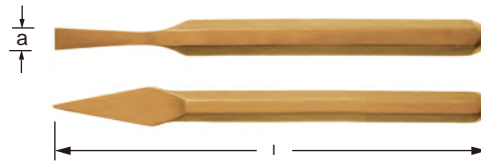

305
 Chisel, Cape

- Kreuzmeissel
- Bédane de mécanicien
- Cortahierro de ranurar

No.	a mm	l mm	Δ kg	a inch	l inch	Wt. lbs.
305-125	9	125	0.15	3/8	5	0.33
305-150	11	150	0.23	7/16	6	0.51
305-175	11	175	0.27	7/16	7	0.59
305-200	12	200	0.37	7/16	8	0.81
305-250	13	250	0.55	1/2	10	1.21
305-300	14	300	0.76	9/16	12	1.68



306
 Chisel, Bull Point

- Pressluftspitzmeissel
- Fleuret
- Rompedor

No.	s mm	l mm	Δ kg	s inch	l inch	Wt. lbs.
306-200	14	200	0.26	9/16	8	0.57
306-250	16	250	0.43	5/8	10	0.94
306-300	18	300	0.65	11/16	12	1.43
306-400	20	400	1.09	3/4	16	2.40



307
 Chisel, Diamond Point

- Diamantspitzmeissel
- Burin à pointe, forme diamant
- Cincel punta de diamante

No.	s mm	l mm	Δ kg	s inch	l inch	Wt. lbs.
307-200	14	200	0.26	9/16	8	0.58
307-250	16	250	0.43	5/8	10	0.94
307-300	18	300	0.65	11/16	12	1.44
307-400	20	400	1.09	3/4	16	2.41

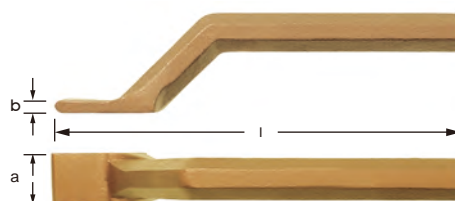

308A
 Caulking Tool

- Stemmwerkzeug, gekröpft
- Mator
- Herramienta de rematar

No.	a mm	b mm	l mm	Δ kg	a inch	b inch	l inch	Wt. lbs.
308A-200	40	10	200	0.40	1 ⁹ / ₁₆	3/8	8	0.87
308A-230	46	11	230	0.60	1 ¹³ / ₁₆	7/16	9 ³ / ₁₆	1.33
308A-260	52	13	260	0.87	2 ¹ / ₁₆	1/2	10 ³ / ₈	1.92

When ordering, specify:

A=Aluminum Bronze
B=Copper Beryllium
Example: 309CP-21A

or
309CP-21B

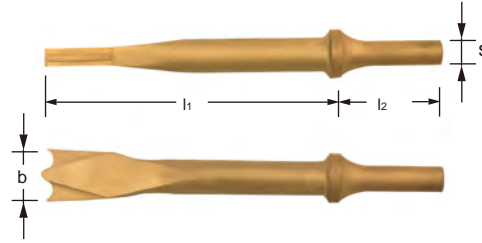

309CP
Chisel, For Machines

- Meissel für Maschinen
- Burin pour les machines
- Cincel para la máquina

No.	b mm	s mm	l ₁ mm	l ₂ mm	Δ kg	b inch	s inch	l ₁ inch	l ₂ inch	Wt. lbs.
309CP-21	21	10	135	40	0.18	13/16	3/8	5 ³ / ₈	1 ⁹ / ₁₆	0.40

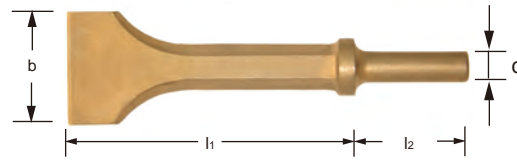

309RP
Chisel, For Machines

- Meissel für Maschinen
- Burin pour les machines
- Cincel para la máquina

No.	b mm	c mm	l ₁ mm	l ₂ mm	Δ kg	b inch	c inch	l ₁ inch	l ₂ inch	Wt. lbs.
309RP-50	50	10	136	39	0.22	2	3/8	5 ⁷ / ₁₆	1 ⁹ / ₁₆	0.49

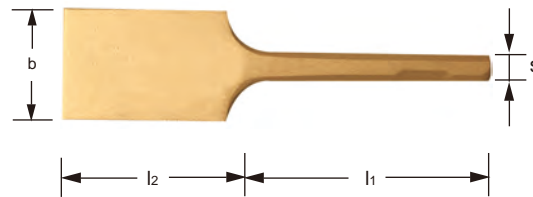

312,312L
Pneumatic Chisel, Scaling

- Preßluftschaber
- Burin de détartrage, pour marteau pneumatique
- Cincel burilador neumático

No.	b mm	s mm	l ₁ mm	l ₂ mm	Δ kg	b inch	s inch	l ₁ inch	l ₂ inch	Wt. lbs.
312-25	25	12.7	65	60	0.16	1	1/2	2 ⁹ / ₁₆	2 ³ / ₈	0.35
312-50	50	12.7	62	60	0.25	2	1/2	2 ⁷ / ₁₆	2 ³ / ₈	0.55
312L-25	25	12.7	104	96	0.27	1	1/2	4	3 ³ / ₄	0.60
312L-50	50	12.7	104	96	0.43	2	1/2	4	3 ³ / ₄	0.95

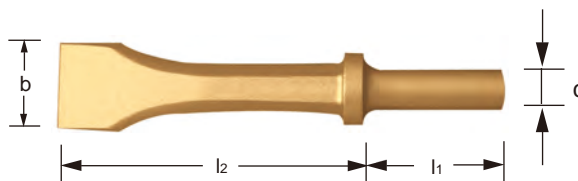

314
Pneumatic Chisel, Scaling

- Preßluftschaber
- Burin de détartrage, pour marteau pneumatique
- Cincel burilador neumático

No.	b mm	c mm	l ₁ mm	l ₂ mm	Δ kg	b inch	c inch	l ₁ inch	l ₂ inch	Wt. lbs.
314-40	40	17.3	60	140	0.57	1 ⁹ / ₁₆	11/16	11/16	5 ⁵ / ₈	1.26
314-65	65	17.3	60	150	0.73	2 ⁹ / ₁₆	11/16	11/16	6	1.61

When ordering, specify:
 A=Aluminum Bronze
 B=Copper Beryllium
 Example:318F-65A
 or
 318F-65B

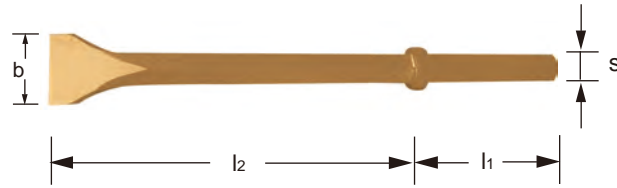

318F, 320F
Pneumatic Chisel, Flat End

- Preßluftflachmeißel
- Burin pour marteau pneumatique
- Cincel neumático

No.	b mm	s mm	l ₁ mm	l ₂ mm	Δ kg	b inch	s inch	l ₁ inch	l ₂ inch	Wt. lbs.
318F-65	65	28.7	153	320	3.12	3	1 ¹ / ₈	6	12 ⁵ / ₈	6.88
318F-75	75	28.7	153	320	3.12	3	1 ¹ / ₈	6	12 ⁵ / ₈	6.88
320F-65	65	32.0	153	320	3.30	3	1 ¹ / ₄	6	12 ⁵ / ₈	7.28
320F-75	75	32.0	153	320	3.30	3	1 ¹ / ₄	6	12 ⁵ / ₈	7.28

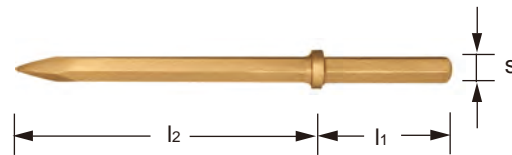

318R, 320R
Pneumatic Chisel, Bull Point

- Preßluftspitzmeißel
- Fleuret pour marteau pneumatique
- Rompedor

No.	s mm	l ₁ mm	l ₂ mm	Δ kg	s inch	l ₁ inch	l ₂ inch	Wt. lbs.
318R-14	28.7	153	332	2.74	1 ¹ / ₈	6	13	6.04
320R-14	32.0	153	332	3.18	1 ¹ / ₄	6	13	7.01

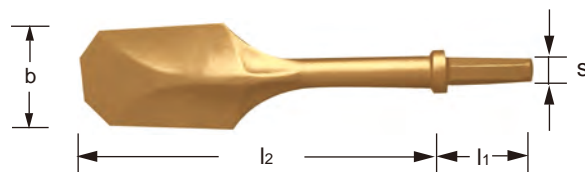

340
Pneumatic Chisel, Spade End

- Preßluftspatenmeißel
- Tranche pour marteau pneumatique
- Pala neumática de arcilla

No.	b mm	s mm	l ₁ mm	l ₂ mm	Δ kg	b inch	s inch	l ₁ inch	l ₂ inch	Wt. lbs.
340-100	108	25.4	108	397	4.89	4 ¹ / ₄	1	4	15 ⁵ / ₈	10.78



CUTTING

Knives Scrapers Saws Files



When ordering, specify:
 A=Aluminum Bronze
 B=Copper Beryllium
 Example: 408-25A
 OR
 408-25B

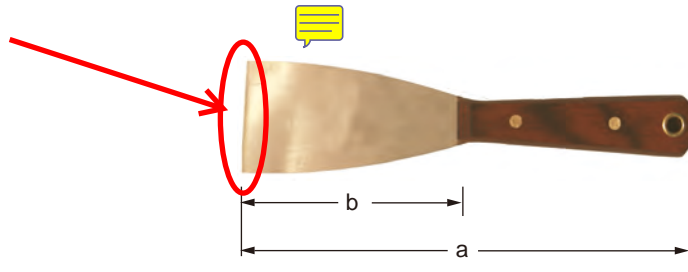

408
 Knife, Putty / Hand Scraper

- Spachtel, starres Blatt
- Couteau de vitrier, lame rigide
- Espátula de hoja rígida

No.	a mm	b mm	Δ kg	a inch	b inch	Wt. lbs.
408-25	25	100	0.05	1	4	0.11
408-30	30	100	0.05	1 ³ / ₁₆	4	0.12
408-40	40	100	0.07	1 ⁹ / ₁₆	4	0.14
408-50	50	100	0.08	2	4	0.17
408-60	60	100	0.09	2 ³ / ₈	4	0.19
408-75	75	100	0.10	3	4	0.22
408-80	80	100	0.11	3 ³ / ₁₆	4	0.24
408-100	100	100	0.13	4	4	0.28

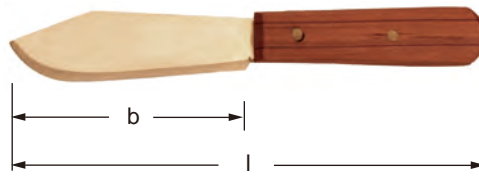

409
 Knife, Common

- Messer
- Couteau, forme droite
- Cuchillo común

No.	b mm	l mm	Δ kg	b inch	l inch	Wt. lbs.
409-200	106	200	0.067	4 ¹ / ₄	8	0.15

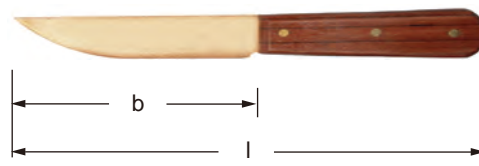

410
 Knife, Common

- Messer
- Couteau, forme droite
- Cuchillo común

No.	b mm	l mm	Δ kg	b inch	l inch	Wt. lbs.
410-250	130	250	0.074	5 ³ / ₁₆	10	0.16

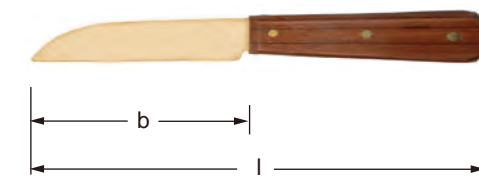

410S
 Knife, Common

- Messer
- Couteau, forme droite
- Cuchillo común

No.	b mm	l mm	Δ kg	b inch	l inch	Wt. lbs.
410S-180	80	180	0.059	3 ³ / ₁₆	7 ³ / ₁₆	0.13

When ordering, specify:

A=Aluminum Bronze

B=Copper Beryllium

Example:401-18A

or

401-18B



401 Scraper Flat

- Flachschräber
- Grattoir de mécanicien
- Raspador plano

No.	a mm	b mm	Δ kg	a inch	b inch	Wt. lbs.
401-18	18	300	0.33	11/16	12	0.73
401-30	30	300	0.53	1 3/16	12	1.17

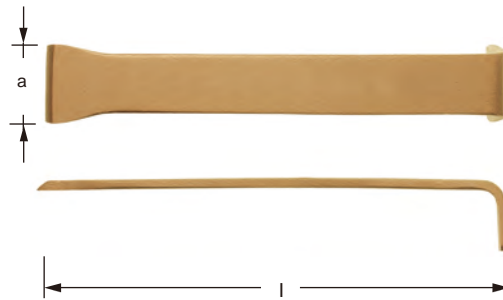

402 Scraper, Angle

- Winkelschräber
- Grattoir angle
- Raspador ángulo

No.	a mm	l mm	Δ kg	a inch	l inch	Wt. lbs.
402-22	22	200	0.22	7/8	8	0.48
402-25	25	300	0.36	1	12	0.78
402-45	45	225	0.50	1 3/4	9	1.10
402-50	50	300	0.71	2	12	1.57



403 Scraper, Triangular

- Dreikantschräber
- Grattoir triangulaire
- Raspador triangular

No.	b mm	Δ kg	b inch	Wt. lbs.
403-300	300	0.31	12	0.68

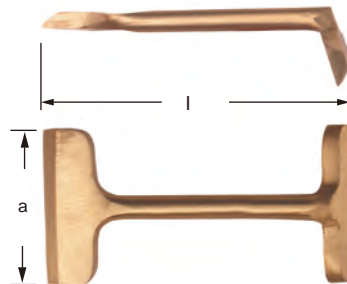

405 Scraper, Deck

- Deck Schräber
- Grattoir de pont
- Rascador de cubierta

No.	a mm	l mm	Δ kg	a inch	l inch	Wt. lbs.
405-75	75	150	0.36	3	6	0.79
405-125	125	235	0.99	5	9 3/8	2.18

When ordering, specify:
 A=Aluminum Bronze
 B=Copper Beryllium
 Example:406-150A
 or
 406-150B



406
 Scraper, Plate

- Dreieckiger Schaber
- Grattoir triangulaire
- Raspador triangular

No.	a mm	l mm	kg	a inch	l inch	Wt. lbs.
406-150	150	485	0.91	6	19 ³ / ₈	2.01

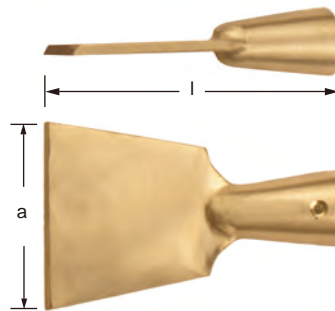

407S
 Scraper
 Handle Sold Separately

- Schabel, ohne Stiel
- Grattoir, sans manche
- Raspador, sin mango

No.	a mm	l mm	kg	a inch	l inch	Wt. lbs.
407S-75	75	115	0.23	3	4 ⁹ / ₁₆	0.51
407S-125	125	200	0.63	5	8	1.39

We can include the handle also:PN WHF 1500

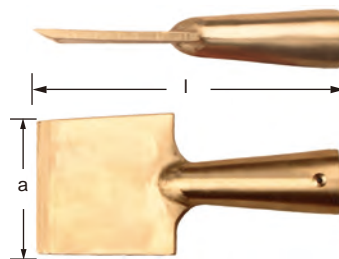

407
 Scraper, Long Blade
 Handle Sold Separately

- Schaber lange Klinge, ohne Stiel
- Grattoir longue lame, sans manche
- Raspador hoja larga, sin mango

No.	a mm	l mm	kg	a inch	l inch	Wt. lbs.
407-60	60	185	0.50	2 ³ / ₈	7 ³ / ₈	1.10
407-100	100	225	1.28	4	9	2.82
407-125	125	225	1.47	5	9	3.24
407-150	150	180	1.11	6	7 ³ / ₁₆	2.45

Handle available PN: WHF 1500

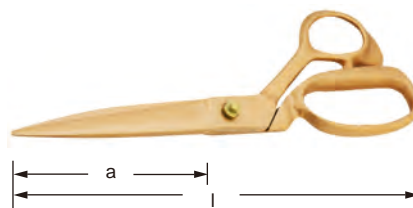

609
 Scissors

- Schere
- Ciseaux
- Tijeras

No.	a mm	l mm	kg	a inch	l inch	Wt. lbs.
609-225	97	225	0.37	3 ⁷ / ₈	9	0.81

When ordering, specify:

A=Aluminum Bronze

B=Copper Beryllium

Example:601-6A

or

601-6B

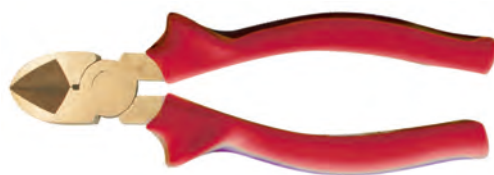

601 Pliers, Diagonal Cutting

- Seitenschneider
- Pince coupante diagonale
- Alicates de corte diagonal

No.	mm	kg	inch	Wt. lbs.
601-6	160	0.18	6 ³ / ₈	0.40
601-8	200	0.24	8	0.53



601HD Pliers, Diagonal Cutting Heavy Duty

- Diagonalschneidezange
- Pinces coupantes diagonales
- Alicates de corte diagonal

No.	mm	kg	inch	Wt. lbs.
601HD-6	160	0.17	6 ³ / ₈	0.37
601HD-7	180	0.21	7 ³ / ₁₆	0.46



603 Pliers, Cutting

- Beisszange
- Tenaille
- Pinza cortadora

No.	mm	kg	inch	Wt. lbs.
603-7	180	0.32	7 ³ / ₁₆	0.71
603-8	200	0.52	8	1.15

When ordering, specify:
 A=Aluminum Bronze
 B=Copper Beryllium
 Example:616-155A
 or
 616-155B

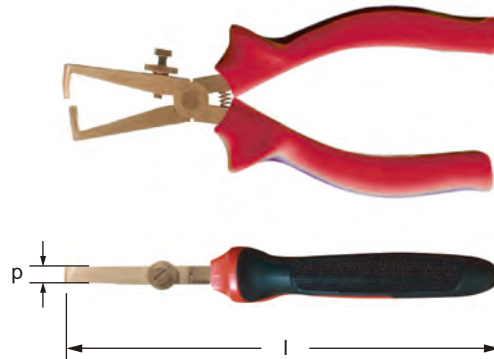

616
 Pliers, wire stripping

- Abisolierzange
- Pince à dénuder
- Pinza quita alambra

No.	Ring dia mm	p mm	l mm	Δ kg
616-155	0.5-5	8	155	0.12

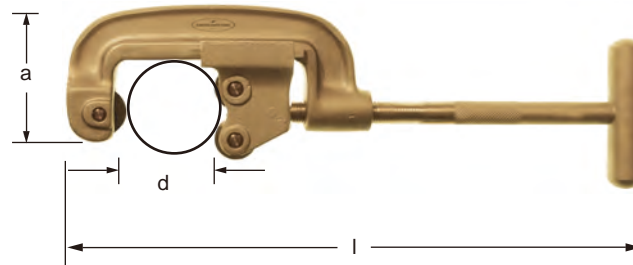

1512
 Pipe Cutter

- Rohrabschneider
- Coupe-tube
- Cortadora tubo

No.	a mm	d max mm	l mm	Δ kg	a inch	d max inch	l inch	Wt. lbs.
1512-60	92	60	445	3.27	3 ¹¹ / ₁₆	2 ³ / ₈	17 ³ / ₄	7.21



308
 Non-Sparking Needle
 For Air Needle Scalers
 Copper Beryllium (CuBe) only

- Funkenfrei nadle für Nadelentrostler
- Aiguilles anti-déflagrantes pour dérouilleur pneumatique
- Agujas anti-chispas de escalador neumatico

No.	a mm	l mm	Δ kg	a inch	l inch	Wt. lbs.
308-3B	3	175	0.01	1/8	7	0.02

When ordering, specify:

A=Aluminum Bronze

B=Copper Beryllium

Example: 118A-300A

or

118B-300B

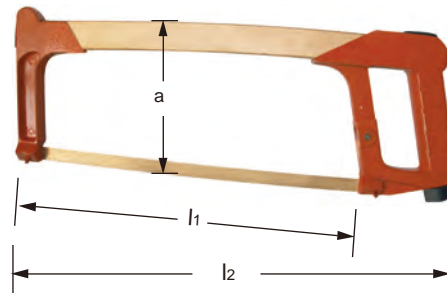

118A Saw, Hand Frame

- Bügelsäge
- Monture de scie à métaux
- Marco para sierra de corte

No.	a mm	l ₁ mm	l ₂ mm	Δ kg	a inch	l ₁ inch	l ₂ inch	Wt. lbs.
118A-300	128	300	395	0.54	5 ^{1/8}	12	15 ^{3/4}	1.19



118B Saw Blade, Hack Copper Beryllium (CuBe) only

- Sägeblatt
- Lame de scie à métaux
- Hoja de sierra de corte

No.	b mm	l mm	Δ kg	b inch	l inch	Wt. lbs.
118B-300B	12	300	0.017	7/16	12	0.04

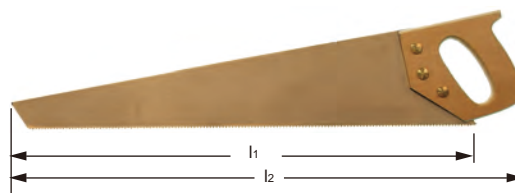

119 Saw, Hand (8 teeth/inch) Copper Beryllium (CuBe) only

- Handsäge (8 Zähne/Zoll)
- Scie égoïne (8 dents/pouce)
- Serrucho de mano (8 dientes/pulgado)

No.	a mm	l mm	Δ kg	a inch	l inch	Wt. lbs.
119-600B	600	680	0.51	24	27 ^{3/16}	1.12



411

File, Half Round, Bastard

Copper Beryllium (CuBe) only

- Halbrundfeile
- Lime demi-ronde
- Lima de media circunferencia

No.	a mm	b mm	△ kg	a inch	b inch	Wt. lbs.
411-200B	20	200	0.19	3/4	8	0.41
411-250B	24	250	0.33	15/16	10	0.73



411R

File, Round

Copper Beryllium (CuBe) only

- Rundfeile
- Lime ronde
- Lime redonda

No.	a mm	b mm	△ kg	a inch	b inch	Wt. lbs.
411R-200B	7	200	0.07	9/32	8	0.15
411R-250B	9	250	0.13	3/8	10	0.30

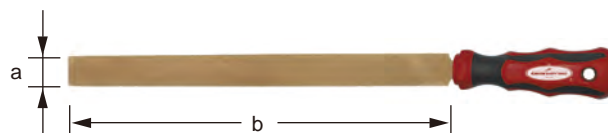

411F

File, Flat, Bastard

Copper Beryllium (CuBe) only

- Flachfeile, Hieb 1
- Lime plate, Taille bâtarde
- Lima de mano, aspero

No.	a mm	b mm	△ kg	a inch	b inch	Wt. lbs.
411F-200B	20	200	0.19	3/4	8	0.41
411F-250B	24	250	0.30	15/16	10	0.67

UTILITIES

Shovels Bars Forks Axels



When ordering, specify:
 A=Aluminum Bronze
 B=Copper Beryllium
 Example: 1004-120A
 or
 1004-120B

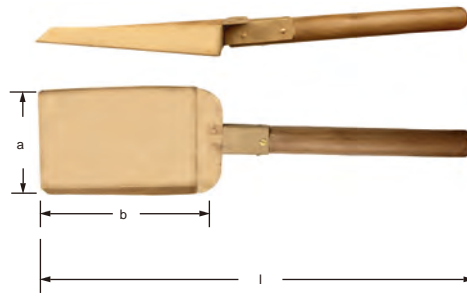

1004
Dust Pan

- Handschaufel
- Pelle à poussière
- Recogedor

No.	a mm	b mm	l mm	Δ kg	a inch	b inch	l inch	Wt. lbs.
1004-120	120	200	520	0.36	4 ^{3/4}	8	20.5	0.79

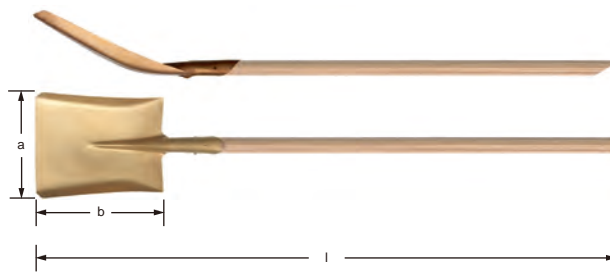

1005
Shovel, Square Point
With Long Handle

- Randschaufel
- Pelle à boue, manche droit
- Pala de punta cuadrada

No.	a mm	b mm	l mm	Δ kg	a inch	b inch	l inch	Wt. lbs.
1005-250	250	300	1450	1.16	10	12	57.1	2.56



1006
Shovel, Round Point
With Long Handle

- Schaufel, Frankfurter form
- Pelle de terrassier, manche droit
- Pala de punta redonda

No.	a mm	b mm	l mm	Δ kg	a inch	b inch	l inch	Wt. lbs.
1006-243	243	300	1450	1.28	9 ^{11/16}	12	57.1	2.82



1007
Spade, Edging
With D-Grip

- Spaten mit D-stiel
- Bêche, manche à poignée
- Azada de borde

No.	a mm	b mm	l mm	Δ kg	a inch	b inch	l inch	Wt. lbs.
1007-180	180	285	1150	1.19	7 ^{3/16}	11 ^{3/8}	45.3	2.62

When ordering, specify:

A=Aluminum Bronze

B=Copper Beryllium

Example: 1008-420A

or

1008-420B

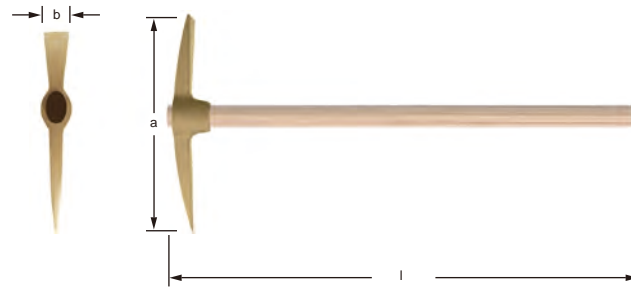

1008
Pick, Railroad or Clay

- Kreuzhacke
- Pioche de terrasier
- Pico de ferrocarril

No.	a mm	b mm	l mm	Δ kg	a inch	b inch	l inch	Wt. lbs.
1008-420	420	25	920	1.20	16 ³ / ₄	1	36.2	2.65
1008-560	560	30	920	2.06	22 ³ / ₈	1 ³ / ₁₆	36.2	4.54
1008-640	640	35	920	4.47	25 ⁹ / ₁₆	1 ³ / ₈	36.2	9.85



1009
Rake

- Rechen
- Râteau
- Rastrillo

No.	a mm	l mm	Δ kg	a inch	l inch	Wt. lbs.
1009-300	300	1350	0.33	12	53.2	0.73

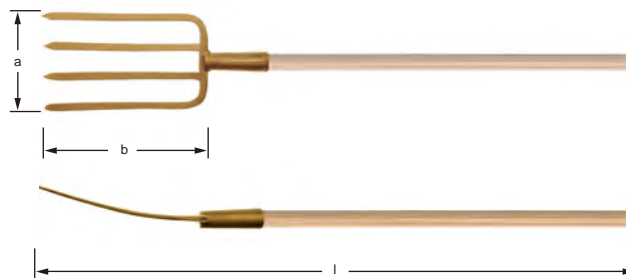

1010
Fork, Garden
(Handle included)

- Spatengabel
- Fourche bêche
- Horquilla de jardín

No.	a mm	b mm	l mm	Δ kg	a inch	b inch	l inch	Wt. lbs.
1010-175	175	280	1340	1.86	7	11 ³ / ₁₆	52.8	4.10



1013
Drum Opener, Carbide

- Karbidtrommelöffner
- Ouvre tonneau à carbure
- Abridor de toneles de carburo

No.	a mm	b mm	l mm	Δ kg	a inch	b inch	l inch	Wt. lbs.
1013-310	45	75	310	0.71	1 ³ / ₄	3	12 ³ / ₈	1.58

When ordering, specify:
 A=Aluminum Bronze
 B=Copper Beryllium
 Example:1014-400A
 or
 1014-400B



1014
 Scraper, Pick and Scaler

- Reinigungswerkzeug
- Pique et Raclette
- Pico y rasqueta

No.	a mm	l mm	Δ kg	a inch	l inch	Wt. lbs.
1014-400	75	400	1.56	3	16	3.44
1014-450	75	450	1.10	3	17 ^{23/32}	2.43

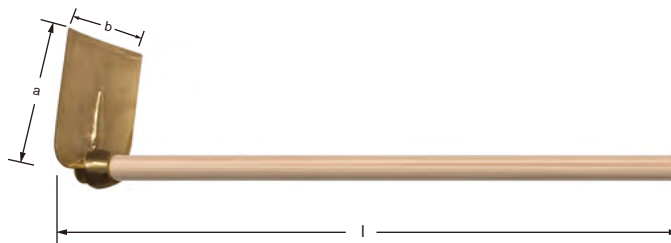

1015
 Hoe, Planters'/ Mixing,
 Angled Blade
 (Handle included)

- Haue
- Houe
- Azadon de plantacion

No.	a mm	b mm	l mm	Δ kg	a inch	b inch	l inch	Wt. lbs.
1015-200	200	200	920	1.88	4	4	36	4.14

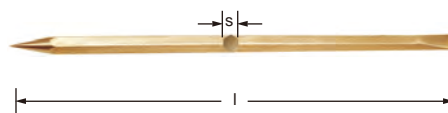

308B
 Caulking Tool

- Stemmwerkzeug
- Matoir
- Herramienta de rematar

No.	s mm	l mm	Δ kg	s inch	l inch	Wt. lbs.
308B-32-1000	32	1000	6.83	1 ^{1/4}	40	15.06
308B-36-1200	36	1200	10.51	1 ^{7/16}	48	23.16
308B-36-1500	36	1500	13.03	1 ^{7/16}	60	28.72
308B-50-1000	50	1000	16.39	2	40	36.13
308B-50-1200	50	1200	20.07	2	48	44.25

When ordering, specify:

A=Aluminum Bronze

B=Copper Beryllium

Example:1301-500A

or

1301-500B



1301 Bar, Pinch

- Brechstange
- Pince à talon
- Barra pie de cabra

No.	s mm	l mm	kg	s inch	l inch	Wt. lbs.
1301-500	19	500	1.22	3/4	20	2.69
1301-800	23	800	2.52	7/8	32	5.56
1301-1000	28	1000	5.01	1 1/8	40	11.04
1301A-1000	30	1000	5.67	1 3/16	40	12.50

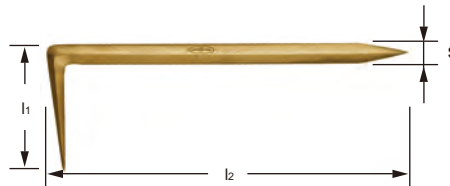

1302 Angle Tracing Point

- Scribe gebogen
- Pointe à tracer coudée
- Scribe doblada

No.	s mm	l ₁ mm	l ₂ mm	kg	s inch	l ₁ inch	l ₂ inch	Wt. lbs.
1302-300	16	116	300	0.58	5/8	4 5/8	12	1.28
1302-500	16	116	500	0.96	5/8	4 5/8	20	2.11
1302-600	20	140	600	1.78	3/4	5 9/16	24	3.93
1302-800	22	162	800	2.86	7/8	6 7/16	32	6.30

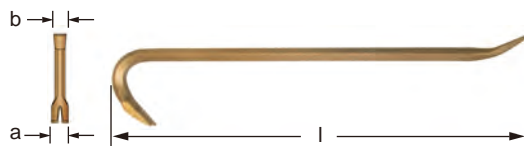

1303 Bar, Crow

- Hebestange
- Pince à levier
- Barra pata de gallo

No.	a mm	b mm	l mm	kg	a inch	b inch	l inch	Wt. lbs.
1303-460	30	22	460	1.39	1 3/16	7/8	18 3/8	3.06
1303-600	35	28	600	2.30	1 3/8	1 1/8	24	5.07
1303-760	35	28	760	3.22	1 3/8	1 1/8	30 3/8	7.09
1303-900	35	28	900	3.52	1 3/8	1 1/8	36	7.76

When ordering, specify:
 A=Aluminum Bronze
 B=Copper Beryllium
 Example:1202-100A
 or
 1202-100B

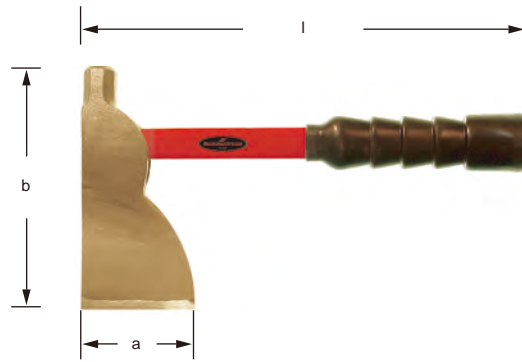

**1202
Hatchet**

- Beil
- Hachette de charpentier
- Hachuela

No.	a mm	b mm	l mm	Δ kg	a inch	b inch	l inch	Wt. lbs.
1202-100	100	180	920	1.90	4	7 ³ / ₁₆	36 ⁷ / ₂₃	4.19

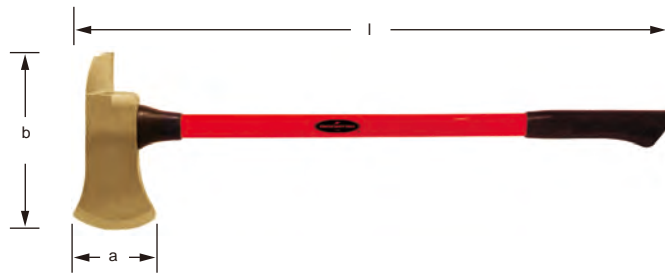

**1203
Axe, Pick Head**

- Feuerwehrraxt
- Hache de pompier
- Hacha de bombero

No.	a mm	b mm	l mm	Δ kg	a inch	b inch	l inch	Wt. lbs.
1203-1850	125	300	920	1.85	5	12	36 ⁷ / ₂₃	4.00
1203-2950	125	300	920	2.95	5	12	36 ⁷ / ₂₃	6.50

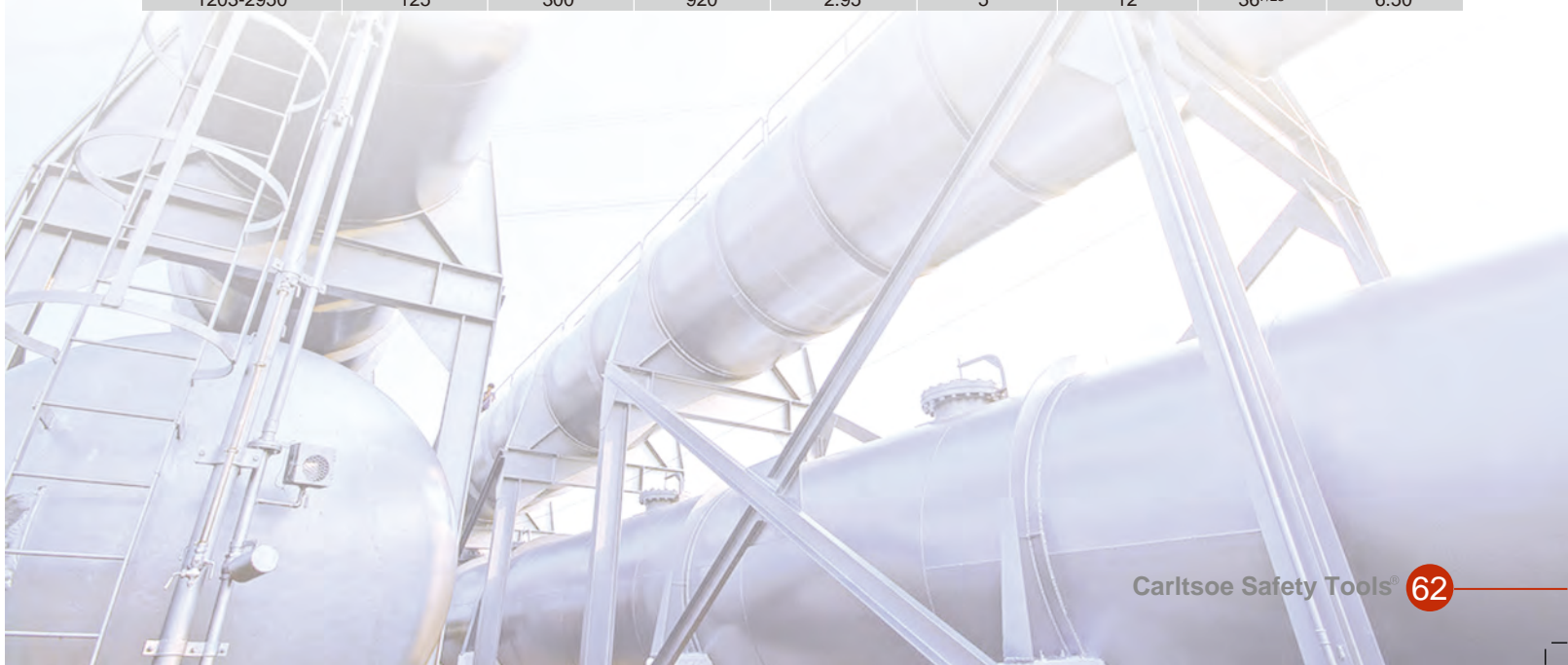



MISCELLANEOUS

Brushes Clamps Bung Wrenches Special Kits



When ordering, specify:
 BR=Brass
 PC=Phosphor Copper
 Example:998-75A
 or
 998-75B

998

Cup Brush, Knot Wire

Both brass and copper phosphorus are available



- Topfbürste, Runddraht gezopft
- Brosse à boisseau, circulaire, fil en tresses
- Cepillo de Copa, circular de Alambre Redondo Rancio

No.	a mm	c	Δ kg	a inch	Wt. lbs.
998-75	75	M14	0.3	3	0.66
998-100	100	M14	0.56	4	1.23
998-150	150	M14	0.9	6	1.98
998U-3	75	5/8	0.3	3	0.66
998U-4	100	5/8	0.56	4	1.23
998U-6	150	5/8	0.9	6	1.98

1000

Brush, Cup

Both brass and copper phosphorus are available

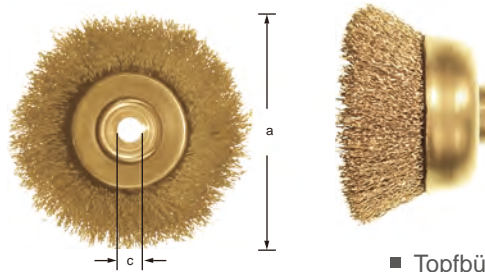

- Topfbürste, Runddraht gewellt
- Brosse à boisseau, circulaire, fil ondulé
- Cepillo de copa, circular, de alambre redondo ondulado

No.	a mm	c	Δ kg	a inch	Wt. lbs.
1000-75	75	M14	0.29	3	0.66
1000-100	100	M14	0.42	4	0.93
1000-150	150	M14	0.57	6	1.26
1000U-3	75	5/8	0.29	3	0.66
1000U-4	100	5/8	0.52	4	1.14
1000U-6	150	5/8	0.93	6	2.05

1001

Brush, Straight Handle, Scratch

Both brass and copper phosphorus are available

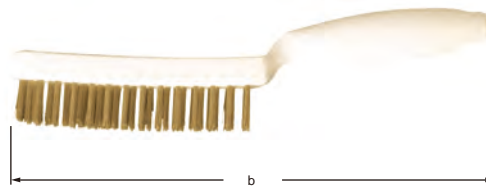

- Handdrahtbürste gerader Griff
- Brosse à main manche droit
- Cepillo de mango derecha

No.	Rows	b mm	Δ kg	b inch	Wt. lbs.
1001-3	3	280	0.15	11 ^{3/16}	0.33
1001-4	4	280	0.20	11 ^{3/16}	0.44

1002

Brush, Flat Back, Scratch

Both brass and copper phosphorus are available



- Kastenbürste
- Brosse à dos plat, dure
- Cepillo de alambre redondo

No.	Rows	b mm	Δ kg	b inch	Wt. lbs.
1002-5	5	185	0.3	7 ^{3/8}	0.66

When ordering, specify:

A=Aluminum Bronze

B=Copper Beryllium

Example:211-160A

or

211-160B

1003 Brush, Wheel

Both brass and copper phosphorus are available

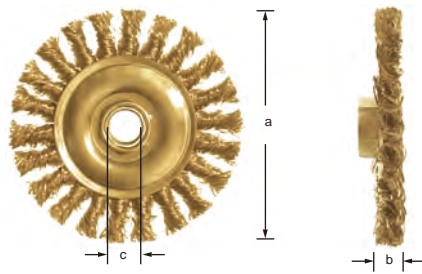

- Rundbürste, Runddraht gezopft
- Brosse circulaire, fil en tresses
- Cepillo, circular de alambre redondo rancio

No.	a mm	b mm	c	Δ kg	a inch	b inch	Wt. lbs.
1003-125	125	20	M14	0.36	5	3/4	0.79

211 Clamp Grounding

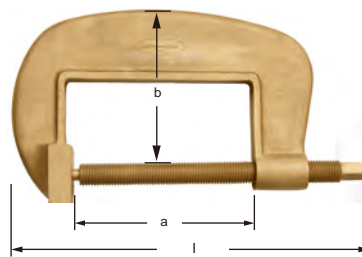

- Polschraubzwinde
- Serre-joint
- Prensa para toma

No.	a mm	b mm	l mm	Δ kg	a inch	b inch	l inch	Wt. lbs.
211-160	160	69.5	310	3.57	6 ^{3/8}	2 ^{3/4}	12 ^{3/8}	7.87

900 Shackle



- Schäkkel
- Manille
- Grillete

No.	a mm	l mm	Δ kg	a inch	l inch	Wt. lbs.
900-30	30	78	1.68	1 ^{3/16}	3 ^{1/8}	3.70

901 Clamp, C-Type

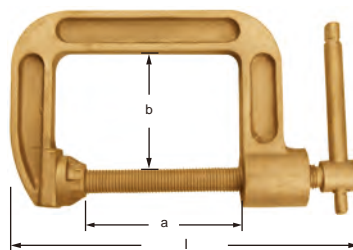

- Schraubzwinde c-type
- Presse serre-joint c-type
- Prensa c-type

No.	a max mm	b mm	l mm	Δ kg	a max inch	b inch	l inch	Wt. lbs.
901-100	100	70	309	1.71	4	2 ^{3/4}	12 ^{3/8}	3.77



902 Parallel Vice

- Parallel Schraubstock
- Etau Parallèle
- Prensa paralela

No.	a max mm	⚖ kg	a max inch	Wt. lbs.
902-100	100	14.64	4	37.21
902-125	125	16.20	5	43.30
902-170	170	17.00	6 ^{11/16}	37.53



903 Chain Block / Hoist

Brass only

- Kettenzug
- Palan
- Polea

No.	Lifting Amount(tons)
903-0.5B	0.5
903-1B	1
903-1.5B	1.5
903-2B	2
903-3B	3
903-5B	5

* FULL TECHNICAL INFORMATION ON DEMAND

903T Trolley For Chain Block / Hoist (One Track)

Brass only

- Waren für Kettenhub (eine Spur)
- Chariot pour palan (une piste)
- Karro para polea (una pista)

No.	Rated Weight Capacity Ton	I-steel Recommended
903T-2B	2t	88-146
903T-3B	3t	100-154
903T-5B	5t	114-170

* FULL TECHNICAL INFORMATION ON DEMAND

When ordering, specify:

A=Aluminum Bronze

B=Copper Beryllium

Example:610-100A

or

610-100B



1017
Bucket
Brass only

- Eimer
- Seau
- Balde

No.	Y 	dh mm	g
1017-300	10	270X280	3000



1601
Ruler

Copper Beryllium (CuBe) only

- Lineal
- Règle
- Regla

No.	l mm	kg	inch	Wt. lbs.	Max Range mm
1601-300B	335	0.07	13 ^{3/8}	0.15	300
1601-500B	543	0.11	21 ^{11/16}	0.24	500



610
Tweezer

- Pinzette
- Pincette
- Pinzeta

No.	l mm	kg	inch	Wt. lbs.
610-100	100	0.022	4	0.05
610-200	200	0.061	8	0.13

When ordering, specify:
 A=Aluminum Bronze
 B=Copper Beryllium
 Example: 610S-155A
 or
 610S-155B

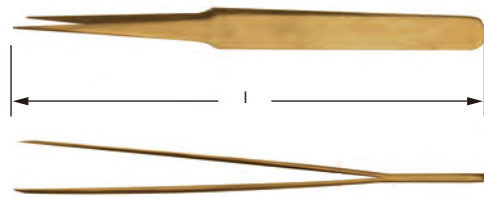

610S
Tweezer

- Pinzette
- Pincette
- Pinzeta

No.	l mm	Δ kg	l inch	Wt. lbs.
610S-155	155	0.046	6 ^{3/16}	0.10

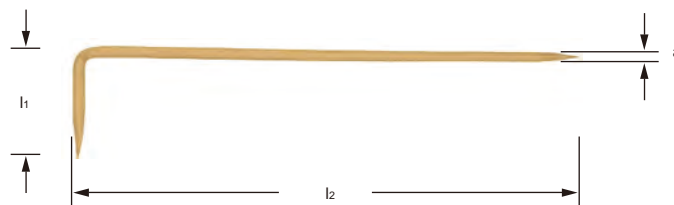

302
Scriber/ Marking Tool

- Markierungswerkzeug
- Traceur
- Trazador

No.	a mm	l ₁ mm	l ₂ mm	Δ kg	a inch	l ₁ inch	l ₂ inch	Wt. lbs.
302-3	3	30	180	0.01	1/8	1 ^{3/6}	7 ^{3/16}	0.02
302-4	4	35	195	0.02	5/32	1 ^{3/8}	7 ^{3/4}	0.04
302-5	5	40	210	0.04	3/16	1 ^{9/16}	8 ^{3/8}	0.09
302-6	6	45	225	0.06	1/4	1 ^{3/4}	9	0.13

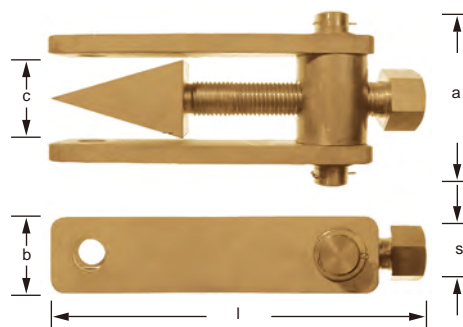

1102
Flange Spreader

- Flanschlösse
- Décolleur
- Veleta difusora

No.	a mm	b mm	c mm	s mm	l mm	Δ kg	a inch	b inch	c inch	s inch	l inch	Wt. lbs.
1102-60	140	60	60	46	305	6.59	5 ^{9/16}	2 ^{3/8}	2 ^{3/8}	1 ^{13/16}	12 ^{3/16}	14.53

When ordering, specify:
 A=Aluminum Bronze
 B=Copper Beryllium
 Example: 110-305A
 or
 110-305B



110 Wrench, Bung Fits 3/4" & 2" Bungs

- Universalfassschlüssel
- Clé universelle pour débonder les fûts
- Llave taponadora universal

No.	mm	kg	inch	Wt. lbs.
110-305	305	0.75	12 ^{3/16}	1.65

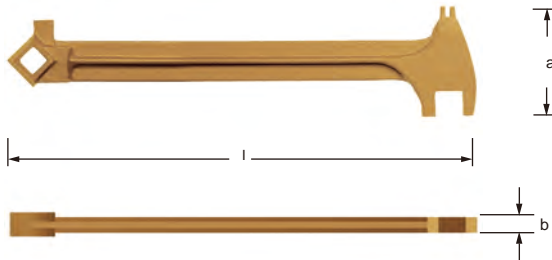

110S Wrench, Bung For 22 Different Bungs

- Universalfassschlüssel
- Clé universelle pour débonder les fûts
- Llave taponadora universal

No.	a mm	b mm	l mm	kg	a inch	b inch	l inch	Wt. lbs.
110S-385	96	66	385	1.82	3 ^{13/16}	2 ^{5/8}	15 ^{3/8}	4.01

2204-4 Engineer's Tools Mini Kit, 4 Piece (Pouch included)

- 5-Stücke Garnitur
- Jeu 5 pièces
- 5 piezas juego

No.	Description	Specification	Quantity
801-6100	Screwdriver-Flat	6X100mm	1
605-8	Combination Pliers	8"	1
113S-230	Crate Opener	230mm	1
501-8	Adjustable End Wrench	8"	1

When ordering, specify:
 A=Aluminum Bronze
 B=Copper Beryllium
 Example:801-6100A
 or
 801-6100B

2206-6
Machinist's Tools Mini Kit, 6 Piece
(Pouch included)

- 7-Stücke Garnitur
- Jeu 7 pièces
- 7 piezas juego

No.	Description	Specification	Quantity
801-6100	Screwdriver-Flat	6X100mm	1
605-8	Combination Pliers	8"	1
113S-230	Crate Opener	230mm	1
501-8	Adjustable End Wrench	8"	1
803-2	Screwdriver-Cross	No.2	1
604-10	Groove Joint Pliers	10"	1

2200-19
Marine Kit, 19 parts
(bag included)

- Marine Kit
- Marine Kit
- Marine Kit

No.	Description	Specification	Quantity
1303-900	Crow Bar	900mm	1
501-10	Adjustable End Wrench	10"	1
501-12	Adjustable End Wrench	12"	1
501-14	Adjustable End Wrench	14"	1
101-0100	Ball Peen Hammer	1lbs	1
101-0200	Ball Peen Hammer	2lbs	1
106-0100	Scaling Hammer	1lbs	3
104-0300	Seldge	3lbs	1
402-50	Angle Scraper	50mm	3
407-100	Long Blade Scraper	100mm	3
406-150	Plate Scraper	150mm	3
801-10200	Screwdriver-Standard	10x200mm	1
803-3	Screwdriver-Phillips	No.3	1
1005-250	D-Handle Shovel	250x300mm	2
305-200	Cape Chisel	12x200mm	1
306-300	Bull Point Chisel	300mm	1
502-10	Pipe Wrench	10"	1
502-14	Pipe Wrench	14"	1
502-18	Pipe Wrench	18"	1

When ordering, specify:

A=Aluminum Bronze

B=Copper Beryllium

Example:2211-10A

or

2211-10B

2211-10 Machinist's Tools Kit, 10 Piece (case included)

- 10-Stücke Garnitur
- Jeu 10 pièces
- 10 piezas juego

No.	Description	Specification	Quantity
408-25	Putty Knife	25mm	1
501-6	Adjustable End Wrench	6"	1
502-10	Adjustable End Wrench	10"	1
504-10	Pipe Wrench	10"	1
604-10	Groove Joint Pliers	10"	1
605-8	Adjustable Pliers	8"	1
122-0100	Claw Hammer	1lbs	1
803-2	Screwdriver-Phillips	No.2	1
801-6100	Screwdriver-Standard	6x100mm	1
1001-4	Brass Brush	4Rows	1

2300-16 Hazmat Kit, 16 Piece (case included)

- HAZMAT - Werkzeugset
- HAZMAT - Jeu d'outils
- HAZMAT - Juego de herramientas

No.	Description	Specification	Quantity
122-0100	Claw Hammer	1lbs	1
113S-230	Crate Opener	230mm	1
405-125	Deck Scraper	125mm	1
406-150	Plate Scraper	150mm	1
408-25	Putty Knife	25mm	1
410-250	Common Knife	250mm	1
501-8	Adjustable End Wrench	8"	1
501-12	Adjustable End Wrench	12"	1
502-14	Pipe Wrench	14"	1
605-8	Adjustable Pliers	8"	1
604-12	Groove Joint Pliers	12"	1
611-7	Long Nose Pliers	7"	1
608-275	Cutting Shears	275mm	1
801-8150	Screwdriver-Standard	8x150mm	1
803-3	Screwdriver-Phillips	No.3	1
1001-4BR	Brass Brush	4Row	1

When ordering, specify:
 A=Aluminum Bronze
 B=Copper Beryllium
 Example:2000-23A
 or
 2000-23B

2000-23
Safety Tools Kit, 23 Piece
(wooden box included)

- Werkzeugset, Holzkiste
- Jeu d'outils, boîte en bois
- Juego de herramientas, caja de madera

No.	Description	Specification	Quantity
101-0100	Hammer,Ball peen	1lbs	1
104-0500	Hammer Sledge	5lbs	1
106-0150	Hammer Scaling	1.5lbs	2
207-50	Wrench,Valve	50mm	1
301-10	Drift,Cylindrical	10mm	1
304-200	Chisel,Hand	22x220mm	1
402-45	Scraper,Angle	45mm	2
403-300	Scraper,Triangular	300mm	1
407S-75	Scraper	75mm	2
501-10	Wrench,Adjustable End	10"	1
502-15	Wrench,Adjustable End	15"	1
502-12	Wrench,Pipe	12"	1
604-10	Pliers,Groove Joint	10"	1
801-8150	Screwdriver,Standard	8x150mm	1
801-10200	Screwdriver,Standard	10x200mm	1
1001-3	Brush,Straight Handle,Stratch	3Rows	2
1004-120	Dust,Pan	120mm	2
1301-500	Bar,Pinch	500mm	1

May be modified according to your demand
 Weight empty Box:12.100 Kg
 Weight full Box:26.800 Kg

4000-21
Cleaning Kit, 21 Piece
(wooden box included)

- Werkzeugset, Holzkiste
- Jeu d'outils, boîte en bois
- Juego de herramientas, caja de madera

No.	Description	Specification	Quantity
106-0100	Hammer,Scaling	1lbs	2
106-0150	Hammer,Scaling	1.5lbs	2
106-0300	Hammer,Scaling	3lbs	2
401-30	Scraper,Flat	30mm	1
402-25	Scraper,Angle	25mm	6
403-300	Scraper,Triangular	300mm	1
407S-75	Scraper	75mm	3
407S-125	Scraper	125mm	3
1001-3	Brush,Straight Handle,Scratch	3Rows	3
1004-120	Dust,Pan	120mm	1

May be modified according to your demand
 Weight empty Box:12.100 Kg
 Weight full Box:20.400 Kg

When ordering, specify:

A=Aluminum Bronze

B=Copper Beryllium

Example:101-0100A

or

101-0100B

3000-30

Engineer's Tools Kit, Heavy Duty, 30 Piece
(wooden box included)

- Werkzeugset, Holzkiste
- Jeu d'outils, boîte en bois
- Juego de herramientas, caja de madera

No.	Description	Specification	Quantity
101-0100	Hammer,Ball Pen	1lbs	1
104-0500	Hammer,Sledge	5lbs	1
1041-1000	Hammer,Cross Peen	1kg	1
202-1922	Wrench,Box End,Double	19x22mm	1
202-2732	Wrench,Box End,Double	27x32mm	1
203-2227	Wrench,Double	22x27mm	1
203-3236	Wrench,Open End,Double	32x36mm	1
203-4146	Wrench,Open End,Double	41x46mm	1
206-27	Wrench,Combination	27mm	1
206-32	Wrench,Combination	32mm	1
206-36	Wrench,Combination	36mm	1
206-41	Wrench,Combination	41mm	1
206-46	Wrench,Combination	46mm	1
206-50	Wrench,Combination	50mm	1
206-55	Wrench,Combination	55mm	1
304-200	Chisel,Hand	22x200mm	1
305-200	Chisel,Cape	12x200mm	1
402-25	Scraper,Angle	25mm	2
403-300	Scraper,Triangular	300mm	1
501-8	Wrench,Adjustable End	8"	1
501-10	Wrench,Adjustable End	10"	1
502-10	Wrench,Pipe	10"	1
502-12	Wrench,Pipe	12"	1
602-8	Pliers,Pipe	8"	1
801-8150	Screwdriver,Standard	8x150mm	1
801-10200	Screwdriver,Standard	10x200mm	1
1002-5	Brush,Flat Back,Scratch	5Rows	1
1004-120	Dust Pan	120mm	1
1301-500	Bar,Pinch	500mm	1

May be modified according to your demand

Weight empty Box:12.100 Kg

Weight full Box:33.400 Kg





Carltsso Safety Tools[®]



All specifications are subject to change
Photos shown may differ from actual tool
Copyright 2014, AC Safety Tools SA.

Wrenches	Hammers	Knives	Shovels	Brushes
Pipe Wrenches				
Sockets/Ratchets	Punches	Scrapers	Bars	Clamps
Allen Keys				
Valve Wheel Wrench	Chisels	Saws	Forks	Bung Wrenches
Pliers				
Screwdrivers	Wedges	Files	Axels	Special Kits



Carltsø Safety Tools®
Route de Chésalles 48
1723 Marly 1
Switzerland

e-mail: info@carltsøe.com
website: www.carltsøe.com
International Toll Free
+800 8080 5050